



**SPECIFICATION SHEET**

<b>SPECIFICATION SHEET NO.</b>	N0802-SMAJ20A000S0BV
<b>DATE</b>	Aug. 02, 2021
<b>REVISION</b>	A0
<b>DESCRIPTION</b>	<p>SMD Transient Voltage Suppressor (TVs) Diodes, SMA/DO-214AC series,  <a href="#">SMAJ20A</a> Type, 2 Pads, Unidirectional</p> <p>Reverse Stand-off Voltage <b>20.0V</b> Max. Peak Pulse Power: 400 Watts Min.</p> <p>Operating Temp. Range -65°C ~+150°C</p> <p>Package in Tape/Reel, 5000pcs/13" Reel or 2000pcs/7" Reel</p> <p>RoHS/RoHS III compliant</p>
<b>CUSTOMER</b>	
<b>CUSTOMER PART NUMBER</b>	
<b>CROSS REF. PART NUMBER</b>	
<b>ORIGINAL PART NUMBER</b>	MDD SMAJ20A
<b>PART CODE</b>	SMAJ20A000S0BV

<b>VENDOR APPROVE</b>			
Issued/Checked/Approved			
DATE: Aug. 02, 2021			

<b>CUSTOMER APPROVE</b>	
DATE:	

**SMD TRANSIENT VOLTAGE SUPPRESSORS DIODES SMA SERIES**



**MAIN FEATURE**

- The plastic package carries Underwriters Laboratory Flammability Classification 94V-0
- Low profile package
- Built-in strain relief
- High temperature soldering guaranteed: 260°C/ 10 seconds at terminals
- Glass passivated chip junction
- Low inductance
- Excellent clamping capability
- 400W peak pulse power capability at 10/1000µs waveform
- Repetition rate (duty cycle): 0.01%
- Fast response time
- Repetition rate (duty cycle): 0.01%
- Typical IR less than 1µA above 10V

**APPLICATION**

- I/O interface
- AC/DC power supply
- Low frequency signal transmission line (RS232, RS485, etc.)

**RFQ**

[Request For Quotation](#)

**PART CODE GUIDE**

SMA	J20A000	S	0BV
1	2	3	4

- 1) **SMA**: SMD Transient Voltage Suppressor (TVs) Diodes, SMA /DO-214AC series,
- 2) **J20A000**: Type code for original part number SMAJ20A
- 3) **S**: Package code, Tape/reel, 5000pcs/13"Reel or 2000pcs/7" Reel
- 4) **0BV**: Marking code for "BV" on the case surface, Different Marking for different specification.

**SMD TRANSIENT VOLTAGE SUPPRESSORS DIODES SMA SERIES**

**MORE ITEMS AVAILABLE- Unidirectional Type**

SMAJ050A00S0AE	SMAJ060A00S0AG	SMAJ070A00S0AM	SMAJ075A00S0AP	SMAJ085A00S0AT
SMAJ080A00S0AR	SMAJ090A00S0AV	SMAJ10A000S0AX	SMAJ11A000S0AZ	SMAJ12A000S0BE
SMAJ13A000S0BG	SMAJ14A000S0BK	SMAJ15A000S0BM	SMAJ16A000S0BP	SMAJ17A000S0BR
SMAJ18A000S0BT	<b>SMAJ20A000S0BV</b>	SMAJ22A000S0BX	SMAJ24A000S0BZ	SMAJ26A000S0CE
SMAJ28A000S0CG	SMAJ30A000S0CK	SMAJ33A000S0CM	SMAJ36A000S0CP	SMAJ40A000S0CR
SMAJ43A000S0CT	SMAJ45A000S0CV	SMAJ48A000S0CX	SMAJ51A000S0CZ	SMAJ54A000S0RE
SMAJ58A000S0RG	SMAJ60A000S0RK	SMAJ64A000S0RM	SMAJ70A000S0RP	SMAJ75A000S0RR
SMAJ78A000S0RT	SMAJ85A000S0RV	SMAJ90A000S0RX	SMAJ100A00S0RZ	SMAJ110A00S0SE
SMAJ120A00S0SG	SMAJ130A00S0SK	SMAJ150A00S0SM	SMAJ160A00S0SP	SMAJ170A00S0SR
SMAJ180A00S0ST	SMAJ190A00S0SU	SMAJ200A00S0SV	SMAJ210A00S0SW	SMAJ220A00S0GE
SMAJ250A00S0SZ	SMAJ300A00S0TE	SMAJ350A00S0TG	SMAJ400A00S0TK	SMAJ440A00S0TM
SMAJ065A00S0AK				

**MORE ITEMS AVAILABLE- Bidirectional Type**

SMAJ050CA0S0WE	SMAJ060CA0S0WG	SMAJ070CA0S0WM	SMAJ075CA0S0WP	SMAJ080CA0S0WR
SMAJ085CA0S0WT	SMAJ090CA0S0WV	SMAJ10CA00S0WX	SMAJ11CA00S0WZ	SMAJ12CA00S0XE
SMAJ13CA00S0XG	SMAJ14CA00S0XK	SMAJ15CA00S0XM	SMAJ16CA00S0XP	SMAJ17CA00S0XR
SMAJ18CA00S0XT	SMAJ20CA00S0XV	SMAJ22CA00S0XX	SMAJ24CA00S0XZ	SMAJ26CA00S0YE
SMAJ28CA00S0YG	SMAJ30CA00S0YK	SMAJ33CA00S0YM	SMAJ36CA00S0YP	SMAJ40CA00S0YR
SMAJ43CA00S0YT	SMAJ45CA00S0YV	SMAJ48CA00S0YX	SMAJ51CA00S0YZ	SMAJ54CA00S0ZE
SMAJ58CA00S0ZG	SMAJ60CA00S0ZK	SMAJ64CA00S0ZM	SMAJ70CA00S0ZP	SMAJ75CA00S0ZR
SMAJ78CA00S0ZT	SMAJ85CA00S0ZV	SMAJ90CA00S0ZX	SMAJ100CA0S0ZZ	SMAJ110CA0S0VE
SMAJ120CA0S0VG	SMAJ130CA0S0VK	SMAJ150CA0S0VM	SMAJ160CA0S0VP	SMAJ170CA0S0VR
SMAJ180CA0S0VT	SMAJ190CA0S0YU	SMAJ200CA0S0VV	SMAJ210CA0S0YW	SMAJ220CA0S0VX
SMAJ250CA0S0VZ	SMAJ300CA0S0UE	SMAJ350CA0S0UG	SMAJ400CA0S0UK	SMAJ440CA0S0UM
SMAJ065CA0S0AK				

**SMD TRANSIENT VOLTAGE SUPPRESSORS DIODES SMA SERIES**

**DIMENSION (Unit: Inch/mm)**

Image for reference



Marking: BV

SMA/DO-214AC



Recommend Pad Layout



Symbol	Unit (Inch)	Unit (mm)
A	0.066	1.680
B	0.060	1.520
C	0.154	3.900
D	0.095	2.410
E	0.215	5.450

**SMD TRANSIENT VOLTAGE SUPPRESSORS DIODES SMA SERIES**
**MECHANICAL DATA**

Case	Terminals	Polarity	Mounting Position	Weight per piece
JEDEC SMA/DO-214AC molded plastic body	Solder plated, Solderable per MIL-STD-750, Method 2026	Polarity symbol marking on case	Any	0.0020 Ounce, 0.0622 grams

**MAX. RATING & CHARACTERISTICS - Ratings at 25°C ambient temperature unless otherwise specified.**

Parameter	SYMBOLS	VALUE			UNITS
		Min.	Typical	Max.	
Peak pulse power dissipation at 10/1000µs waveform (Note1, Note2, Fig.1)	P ppm	400			W
Peak pulse current of at 10/1000µs waveform (Note 1, Fig.3)	I ppm			12.3	A
Steady state power dissipation at TA=50°C (Fig.5)	P M(AV)		3.3		W
Peak forward surge current 8.3ms single half sine-wave superimposed on rated load (JEDEC Method)	I FSM		40		A
Thermal resistance junction to lead	R QJL		30		°C/W
Thermal resistance junction to ambient	R QJA		120		°C/W
Operating junction temperature range	T J	-65		+150	°C
Storage temperature range	T STG	-65		+150	°C

Note

1. Non-repetitive current pulse, per Fig 3 and derated above TA=25 °C per Fig 2
2. Mounted on 5.0\*5.0mm(Thickness 0.03mm) copper pads to each terminal
3. 8.3ms single half sine – wave or equivalent square wave, duty cycle – 4 pulsed per minute Max

**ELECTRICAL CHARACTERISTICS - Ratings at 25°C**

Parameter	SYMBOLS	VALUE	UNITS
Reverse Stand-Off Voltage	V RWM	20	V
Breakdown Voltage @I T	V BR	22.20~24.50	V
Test Current	I T	1	mA
Maximum Clamping Voltage @I PP	V C	32.40	V
Peak Pulse Current	I PP	12.30	A
Reverse Leakage @V RWM	I R	1	µA

**SMD TRANSIENT VOLTAGE SUPPRESSORS DIODES SMA SERIES**
**RELIABILITY**

Number	Experiment Items	Experiment Method And Conditions	Reference Documents
1	Solder Resistance Test	Test 260°C± 5°C for 10 ± 2 sec. Immerse body into solder 1/16" ± 1/32"	MIL-STD-750D METHOD-2031.2
2	Solderability Test	230°C ±5°C for 5 sec.	MIL-STD-750D METHOD-2026.1 0
3	Pull Test	1 kg in axial lead direction for 10 sec.	MIL-STD-750D METHOD-2036.4
4	Bend Test	0.5Kg Weight Applied To Each Lead, Bending Arcs 90 °C ± 5 °C For 3 Times	MIL-STD-750D METHOD-2036.4
5	High Temperature Reverse Bias Test	TA=100°C for 1000 Hours at VR=80% Rated VR	MIL-STD-750D METHOD-1038.4
6	Forward Operation Life Test	TA=25°C Rated Average Rectified Current	MIL-STD-750D METHOD-1027.3
7	Intermittent Operation Life Test	On state: 5 min with rated IRMS Power Off state: 5 min with Cool Forced Air. On and off for 1000 cycles.	MIL-STD-750D METHOD-1036.3
8	Pressure Cooker Test	15 PSIG, TA=121°C, 4 hours	MIL-S-19500 APPENOIXC
9	Temperature Cycling Test	-55°C~+125°C; 30 Minutes For Dwelled Time 5 minutes for transferred time. Total: 10 cycles.	MIL-STD-750D METHOD-1051.7
10	Thermal Shock Test	0°C for 5 minutes., 100°C for 5minutes, Total: 10 cycles	MIL-STD-750D METHOD-1056.7
11	Forward Surge Test	8.3ms Single Sale Sine-wave One Surge.	MIL-STD-750D METHOD-4066.4
12	Humidity Test	TA=65°C, RH=98% for 1000 hours.	MIL-STD-750D METHOD-1021.3
13	High Temperature Storage life Test	150°C for 1000 Hours	MIL-STD-750D METHOD-1031.5

**SMD TRANSIENT VOLTAGE SUPPRESSORS DIODES SMA SERIES**

**SUGGESTED REFLOW PROFILE (For Reference Only)**



<b>Profile Feature</b>		Pb-Free Assembly
<b>Average Ramp-up Rate (Ts Max to Tp)</b>		3°C/second Max
<b>Preheat</b>	<b>Temperature Min (Ts Min.)</b>	150°C
	<b>Temperature Max (Ts Max.)</b>	200°C
	<b>Time (ts Min. to ts Max.)</b>	60 ~ 180 seconds
<b>Time maintained above</b>	<b>Temperature (Tl)</b>	217°C
	<b>Time (tL)</b>	60 ~ 150 seconds
<b>Peak/Classification Temperature (Tp)</b>		260 °C
<b>Time within 5°C of actual Peak Temperature (tp)</b>		20 ~ 40 seconds
<b>Ramp-down rate</b>		6 °C /Second Max.
<b>Time 25 °C to Peak Temperature</b>		8 minutes Max.
<b>Suggest reflow times</b>		3 Times Max.

**SMD TRANSIENT VOLTAGE SUPPRESSORS DIODES SMA SERIES**

**RATINGS AND CHARACTERISTIC CURVES (For Reference Only)**

Figure 1. Peak Pulse Power Rating Curve



Figure 2. Pulse Derating Curve

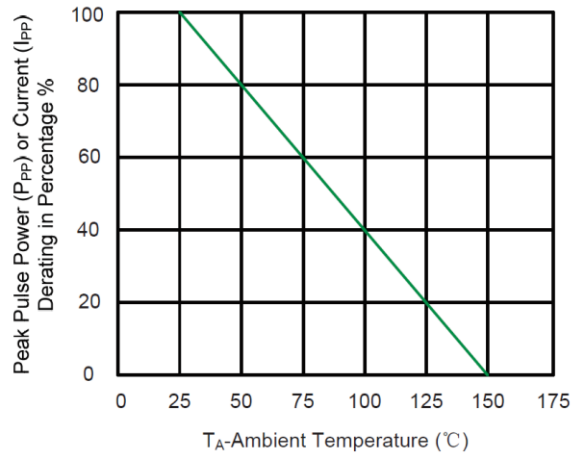

Figure 3. Pulse Waveform

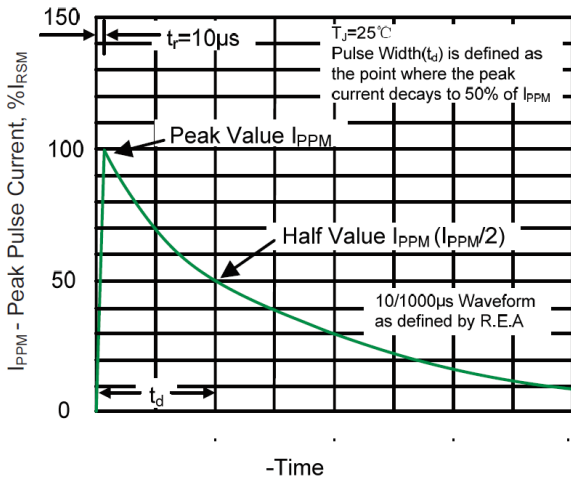

Figure 5. Steady State Power Dissipation Derating curve

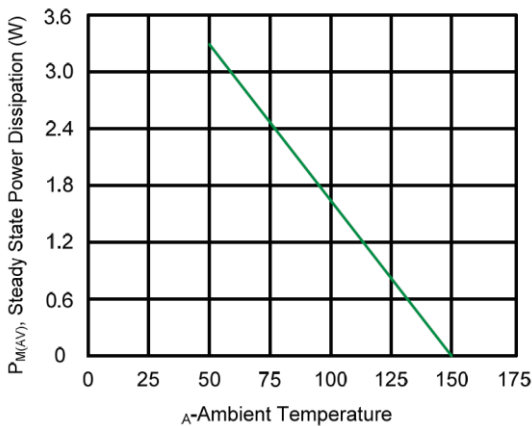
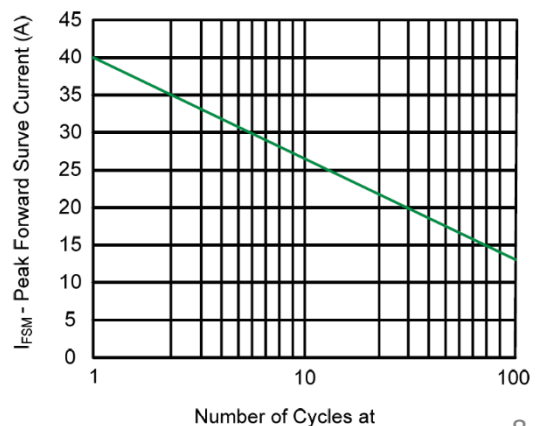

Figure 4. Typical Junction Capacitance



Figure 6. Maximum Non-Repetitive Forward Surge Current Uni-Directional Only





**SMD TRANSIENT VOLTAGE SUPPRESSORS DIODES SMA SERIES**

**TAPE/REEL (Unit: mm)**

All Devices are packed in accordance with EIA standard RS-481-A and specifications.



Item	Symbol	Tolerance	SMA/DO-214AC
Carrier width	A	0.1	2.8
Carrier Length	B	0.1	5.33
Carrier Depth	C	0.1	2.36
Sprocket hole	d	0.05	1.50
13" Reel outside diameter	D	2.0	330.0
13" Reel inner diameter	D1	-	50.0Min.
7" Reel outside diameter	D	2.0	178.0
7" Reel inner diameter	D1	-	62.0
Feed hole diameter	D2	0.5	13.00
Sprocket hole position	E	0.1	1.75
Punch hole position	F	0.1	5.50
Punch hole pitch	P	0.1	4.00
Sprocket hole pitch	P0	0.1	4.00
Embossment center	P1	0.1	2.0
Overall tape thickness	T	0.1	0.28
Tape width	W	0.3	12.00
Reel width	W1	1.0	18.0

**SMD TRANSIENT VOLTAGE SUPPRESSORS DIODES SMA SERIES**

**PACKAGE**

Case Code	Reel Size	MPQ (pcs)	Component Spacing (mm)	Qty. Per Box (pcs)	Inner Box L*W*H (mm)	Reel Size (mm)	Carton size L*W*H (mm)	Qty. Per Carton (pcs)	G. W (kg)
SMA	7"	2,000		2,000	185*185*40	178	400*400*250	80,000	12.0
SMA	13"	5,000		5,000	335*335*40	330	380*380*380	80,000	12.0

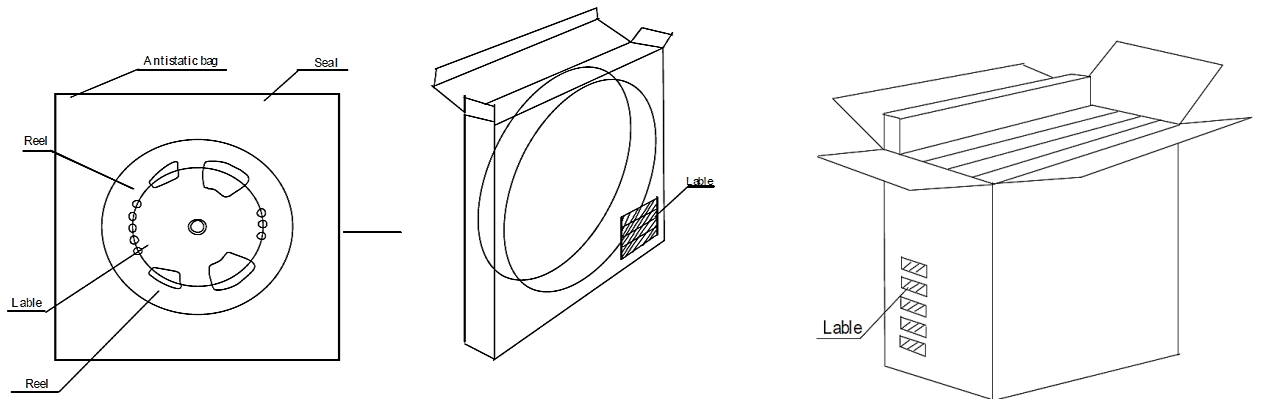

**DISCLAIMER**

NextGen Component, Inc. reserves the right to make changes to the product(s) and or information contained herein without notice. No liability is assumed as a result of their use or application. No rights under any patent accompany the sale of any such product(s) or information