



**SPECIFICATION SHEET**

<b>SPECIFICATION SHEET NO.</b>	P0319 - SMBES5D000S520
<b>DATE</b>	March 19, 2022
<b>REVISION</b>	A0
<b>DESCRIPTION</b>	<p>SMD Super Fast Recovery Rectifier, SMB series, ES5DB Type, 2 Pads</p> <p>Reverse Voltage 200V Max. Forward Current 5.0A Max.</p> <p>Operating Temp. Range -55°C ~+150°C</p> <p>Package in Tape/Reel, 3000pcs/13" Reel</p> <p>RoHS/RoHS III compliant</p>
<b>CUSTOMER</b>	
<b>CUSTOMER PART NUMBER</b>	
<b>CROSS REF. PART NUMBER</b>	
<b>ORIGINAL PART NUMBER</b>	MDD ES5DB
<b>PART CODE</b>	SMBES5D000S520

<b>VENDOR APPROVE</b>			
Issued/Checked/Approved			
DATE: March 19, 2022			

<b>CUSTOMER APPROVE</b>	
DATE:	

3/21/2022

**SMD SUPER FAST RECOVERY RECTIFIER SMB SERIES**



**MAIN FEATURE**

- The plastic package carries Underwriters Laboratory Flammability Classification 94V-0
- Low reverse leakage
- Built-in strain relief
- High forward surge current capability
- High temperature soldering guaranteed: 250°C/ 10 seconds at terminals
- Glass passivated chip junction

**APPLICATION**

- For SMD application

**RFQ**

[Request For Quotation](#)

**PART CODE GUIDE**

SMB	ES5D000	S	520
1	2	3	4

- 1) **SMB**: SMD Super Fast Recovery Rectifier, SMB/DO-214AA series code
- 2) **ES5D000**: Type code for ES5DB
- 3) **S**: Package code, Tape/reel, 3000pcs/13" reel.
- 4) **520**: Specification code for Forward Current 5.0A Max. Reverse Voltage 200V Max.

**SMD SUPER FAST RECOVERY RECTIFIER SMB SERIES**

**DIMENSION (Unit: Inch/mm)**

Image for reference



Marking: ES5DB

SMB/DO-214AA

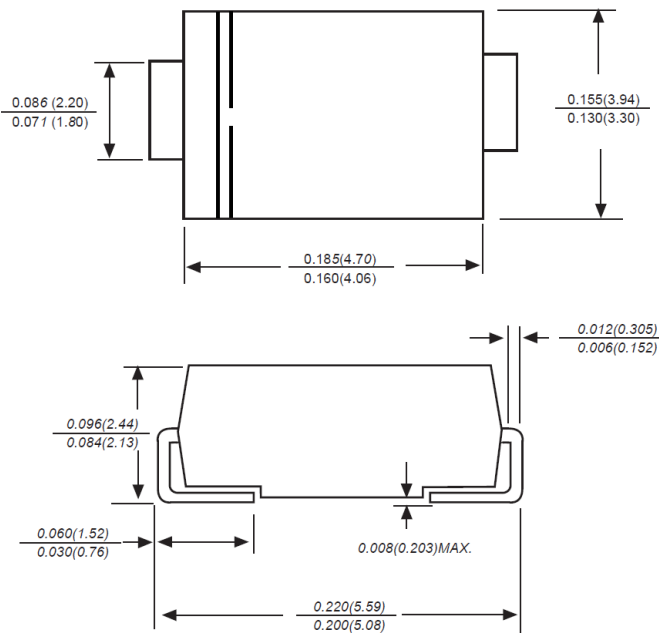

Recommend Pad Layout

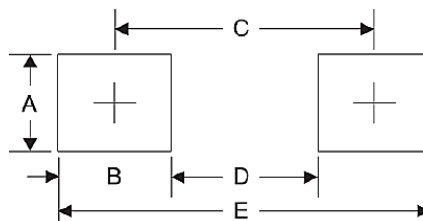

Symbol	Unit (inch)	Unit (mm)
A	0.110	2.80
B	0.094	2.40
C	0.181	4.60
D	0.086	2.20
E	0.276	7.00

**SMD SUPER FAST RECOVERY RECTIFIER SMB SERIES**
**MECHANICAL DATA**

Case	Terminals	Polarity	Mounting Position	Weight per piece
JEDEC SMB/DO-214AA molded plastic body	Solder plated, Solderable per MIL-STD-750, Method 2026	Polarity symbol marking on case	Any	0.0030 Ounce, 0.100 grams

**MAX. RATING & CHARACTERISTICS**

Parameter	SYMBOLS	VALUE			UNITS
		Min.	Typical	Max.	
Repetitive peak reverse voltage	V <sub>RRM</sub>			200	Volts
RMS voltage	V <sub>RMS</sub>			140	Volts
DC blocking voltage	V <sub>DC</sub>			200	Volts
Average forward output rectified current at TL= 125°C	I <sub>AV</sub>			5.0	A
Peak forward surge current 8.3ms single half sine-wave superimposed on rated load (JEDEC Method)	I <sub>FSM</sub>		150		A
Instantaneous forward voltage at 5.0A	V <sub>F</sub>			1.00	Volts
DC reverse current at rated DC blocking voltage	I <sub>R</sub>	TA=25°C		10.0	μA
		TA=125°C		100	μA
Reverse recovery Time (Note 2)	t <sub>rr</sub>			35	ns
Junction capacitance (NOTE 3)	C <sub>J</sub>		95		pF
Thermal resistance (Note 4)	R <sub>θJA</sub>		45		°C/W
Operating junction temperature range	T <sub>J</sub>	-55		+150	°C
Storage temperature range	T <sub>STG</sub>	-55		+150	°C

**Note**

- Ratings at 25 C ambient temperature unless otherwise specified. Single phase half-wave 60Hz, resistive or inductive load, for capacitive load current derate by 20%.
- Reverse recovery condition IF=0.5A,IR=1.0A,Irr=0.25A
- Measured at 1.0MHz and applied reverse voltage of 4.0Voltage
- P.C.B. mounted with 0.2x0.2"(5.0x5.0mm) copper pad areas.

**SMD SUPER FAST RECOVERY RECTIFIER SMB SERIES**
**RELIABILITY**

Number	Experiment Items	Experiment Method And Conditions	Reference Documents
1	Solder Resistance Test	Test 260°C± 5°C for 10 ± 2 sec. Immerse body into solder 1/16" ± 1/32"	MIL-STD-750D METHOD-2031.2
2	Solderability Test	230°C ±5°C for 5 sec.	MIL-STD-750D METHOD-2026.1 0
3	Pull Test	1 kg in axial lead direction for 10 sec.	MIL-STD-750D METHOD-2036.4
4	Bend Test	0.5Kg Weight Applied To Each Lead, Bending Arcs 90 °C ± 5 °C For 3 Times	MIL-STD-750D METHOD-2036.4
5	High Temperature Reverse Bias Test	TA=100°C for 1000 Hours at VR=80% Rated VR	MIL-STD-750D METHOD-1038.4
6	Forward Operation Life Test	TA=25°C Rated Average Rectified Current	MIL-STD-750D METHOD-1027.3
7	Intermittent Operation Life Test	On state: 5 min with rated IRMS Power Off state: 5 min with Cool Forced Air. On and off for 1000 cycles.	MIL-STD-750D METHOD-1036.3
8	Pressure Cooker Test	15 PSIG, TA=121°C, 4 hours	MIL-S-19500 APPENOIXC
9	Temperature Cycling Test	-55°C~+125°C; 30 Minutes For Dwelled Time 5 minutes for transferred time. Total: 10 cycles.	MIL-STD-750D METHOD-1051.7
10	Thermal Shock Test	0°C for 5 minutes., 100°C for 5minutes, Total: 10 cycles	MIL-STD-750D METHOD-1056.7
11	Forward Surge Test	8.3ms Single Sale Sine-wave One Surge.	MIL-STD-750D METHOD-4066.4
12	Humidity Test	TA=65°C, RH=98% for 1000 hours.	MIL-STD-750D METHOD-1021.3
13	High Temperature Storage life Test	150°C for 1000 Hours	MIL-STD-750D METHOD-1031.5

**SMD SUPER FAST RECOVERY RECTIFIER SMB SERIES**

**SUGGESTED REFLOW PROFILE (For Reference Only)**

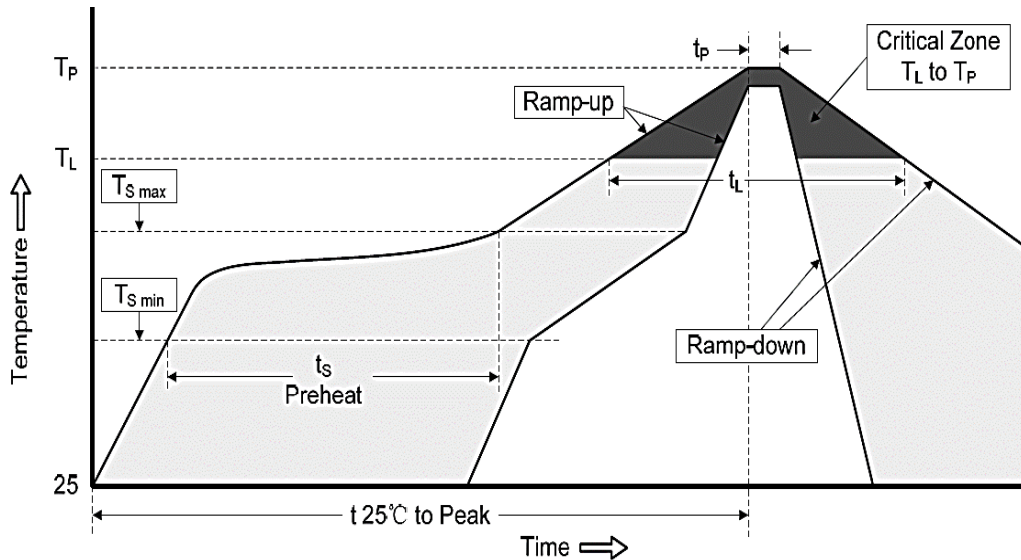

<b>Profile Feature</b>		Pb-Free Assembly
<b>Average Ramp-up Rate (Ts Max to Tp)</b>		3°C/second Max
<b>Preheat</b>	<b>Temperature Min (Ts Min.)</b>	150°C
	<b>Temperature Max (Ts Max.)</b>	200°C
	<b>Time (ts Min. to ts Max.)</b>	60 ~ 180 seconds
<b>Time maintained above</b>	<b>Temperature (Tl)</b>	217°C
	<b>Time (ti)</b>	60 ~ 150 seconds
<b>Peak/Classification Temperature (Tp)</b>		250 °C
<b>Time within 5°C of actual Peak Temperature (tp)</b>		3 ~ 10 seconds
<b>Ramp-down rate</b>		6 °C /Second Max.
<b>Time 25 °C to Peak Temperature</b>		8 minutes Max.
<b>Suggest reflow times</b>		3 Times Max.

**SMD SUPER FAST RECOVERY RECTIFIER SMB SERIES**

**RATINGS AND CHARACTERISTIC CURVES (For Reference Only)**

Fig.1 Reverse Recovery Time Characteristic And Test Circuit Diagram

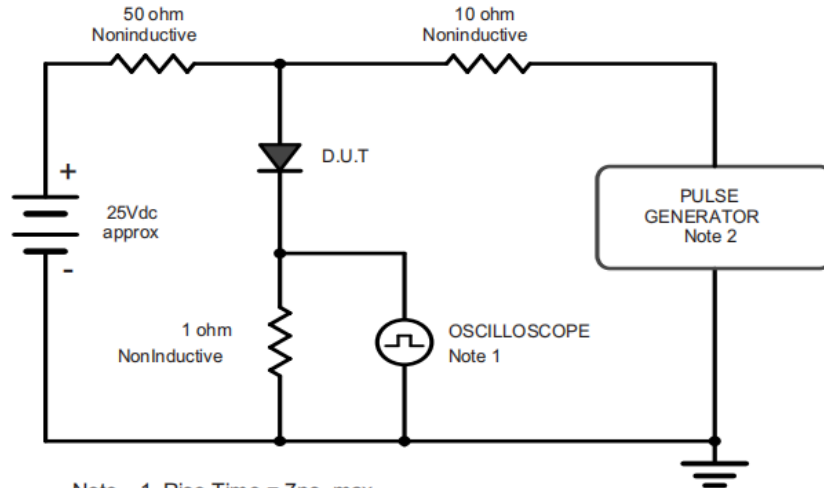

- Note: 1. Rise Time = 7ns, max.  
Input Impedance = 1megohm, 22pF.  
2. Rises Time = 10ns, max.  
Source Impedance = 50 ohms.

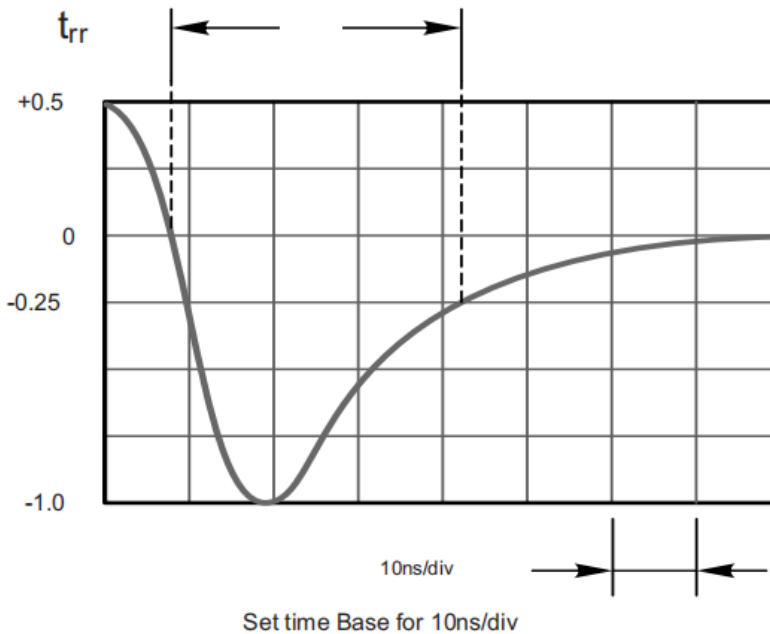

**SMD SUPER FAST RECOVERY RECTIFIER SMB SERIES**

**RATINGS AND CHARACTERISTIC CURVES (For Reference Only)**

**Fig.2 Maximum Average Forward Current Rating**

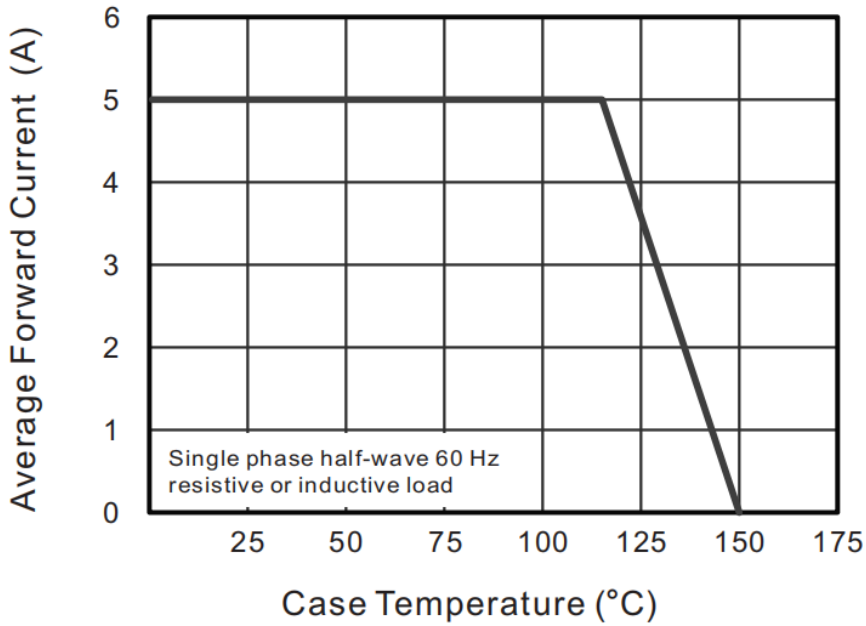

**Fig.3 Typical Reverse Characteristics**

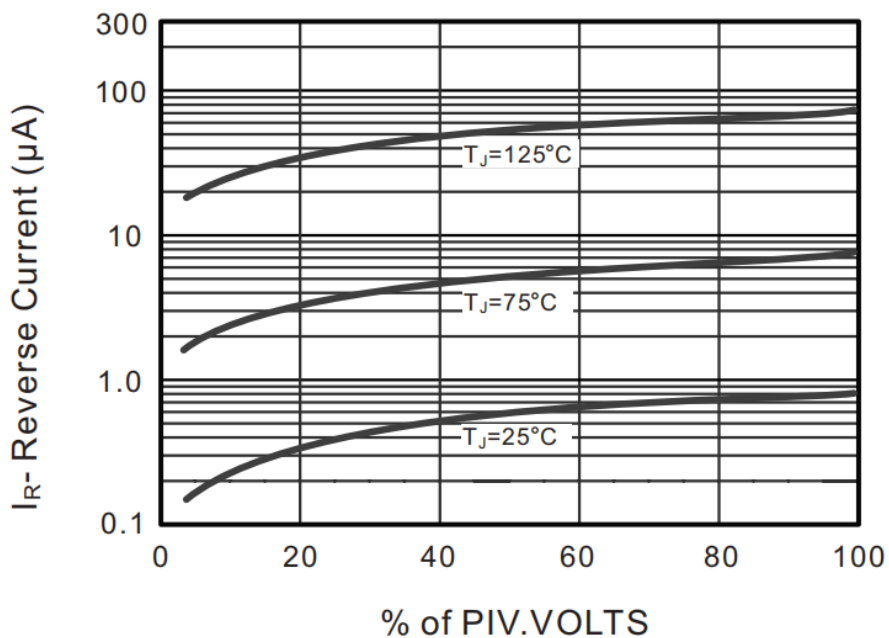



**SMD SUPER FAST RECOVERY RECTIFIER SMB SERIES**

**RATINGS AND CHARACTERISTIC CURVES (For Reference Only)**

**Fig.4 Typical Forward Characteristics**

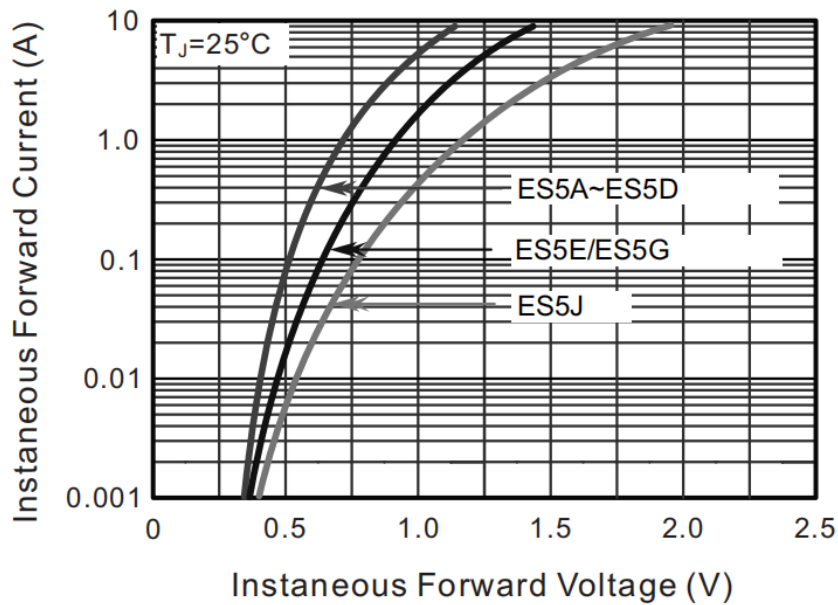

**Fig.5 Typical Junction Capacitance**

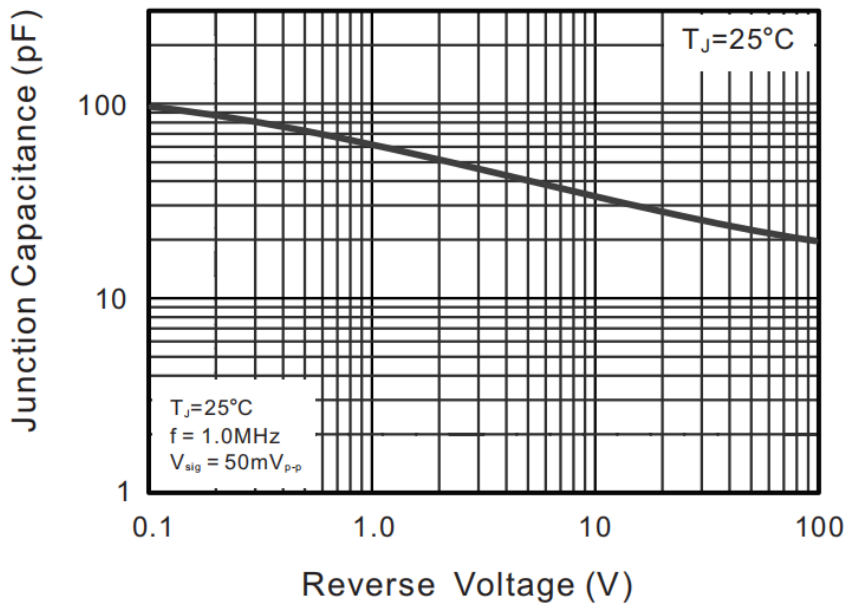

**SMD SUPER FAST RECOVERY RECTIFIER SMB SERIES**

**RATINGS AND CHARACTERISTIC CURVES (For Reference Only)**

**Fig.6 Maximum Non-Repetitive Peak Forward Surge Current**

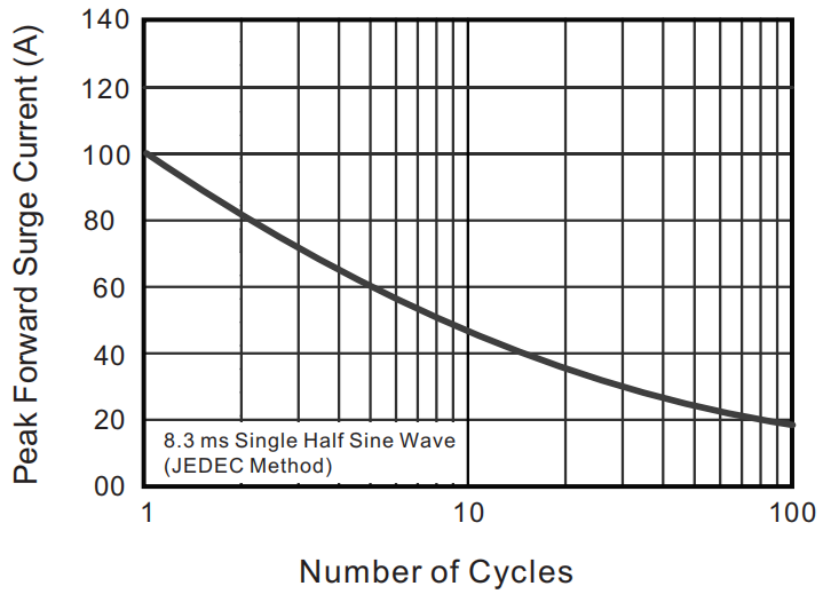

**SMD SUPER FAST RECOVERY RECTIFIER SMB SERIES**

**TAPE/REEL (Unit: mm)**

All Devices are packed in accordance with EIA standard RS-481-A and specifications.

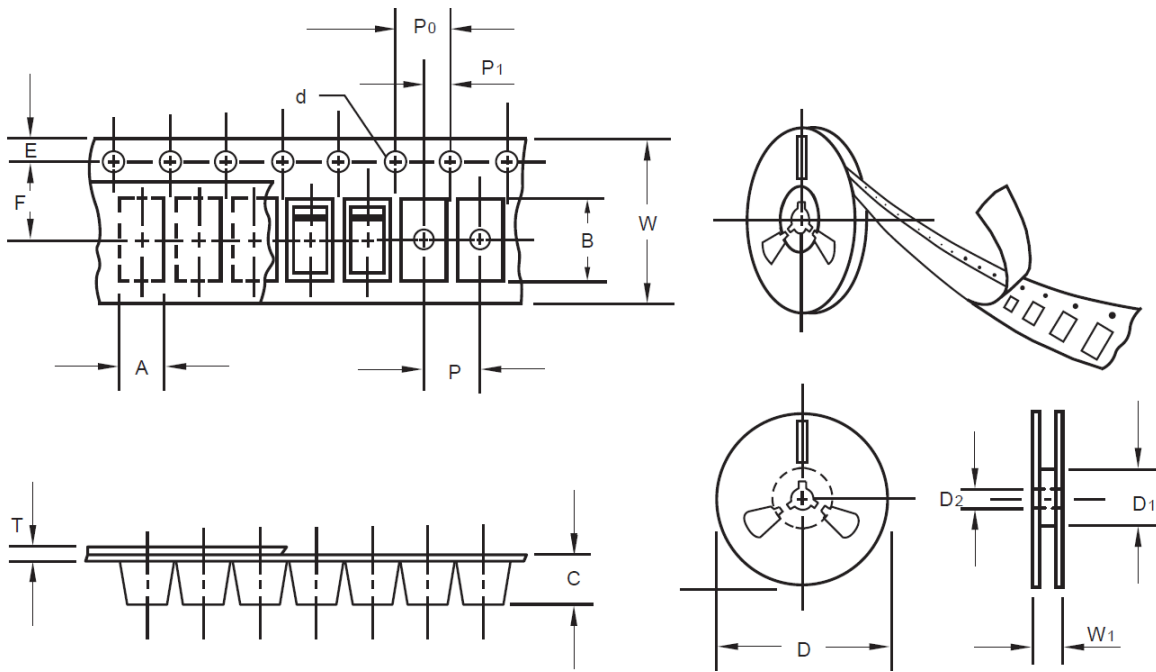

Item	Symbol	Tolerance	SMB/DO-214AA
Carrier width	A	0.1	3.81
Carrier Length	B	0.1	5.41
Carrier Depth	C	0.1	2.42
Sprocket hole	d	0.05	1.50
13" Reel outside diameter	D	2.0	330.00
13" Reel inner diameter	D1	Min.	50.00
7" Reel outside diameter	-	-	-
7" Reel inner diameter	-	-	-
Feed hole diameter	D2	0.5	13.00
Sprocket hole position	E	0.1	1.75
Punch hole position	F	0.1	5.55
Punch hole pitch	P	0.1	8.00
Sprocket hole pitch	P0	0.1	4.00
Embossment center	P1	0.1	2.00
Overall tape thickness	T	0.1	0.30
Tape width	W	0.3	12.00
Reel width	W1	1.0	12.30

**SMD SUPER FAST RECOVERY RECTIFER SMB SERIES**

**SPQ PACKAGE for Reference**

Item	Unit	Value
Case Code		SMB/DO-214AA
Reel Size	Inch	13
Reel Size	mm	330
Tape Space	mm	/
SPQ /Reel	pcs	3000
Weigh /SPQ	LBS	4.63
Weigh /SPQ	KGs	2.10
Qty. Per Box	pcs	6,000
Inner Box	Inch	L13.2*W13.2*H1.95

**DISCLAIMER**

NextGen Component, Inc. reserves the right to make changes to the product(s) and or information contained herein without notice. No liability is assumed as a result of their use or application. No rights under any patent accompany the sale of any such product(s) or information