



SPECIFICATION SHEET

SPECIFICATION SHEET NO.	N0310-SOD323C15SS0WJ
DATE	Mar. 10, 2021
REVISION	A0
DESCRIPTION	SMD Zener Diodes, SOD-323 series, BZT52C15S Type, 2 Pads Zener Voltage 5.1 Volts Typical, Peak Pulse Power - 200 mW Operating Temp. Range -65°C ~+150°C Package in Tape/Reel, 3000pcs/Reel RoHS/RoHS III compliant
CUSTOMER	
CUSTOMER PART NUMBER	
CROSS REF. PART NUMBER	
ORIGINAL PART NUMBER	MDD BZT52C15S
PART CODE	SOD323C15SS0WJ

VENDOR APPROVE			
Issued/Checked/Approved			
DATE: March 10, 2021			

CUSTOMER APPROVE	
DATE:	

SMD ZENER DIODES SOD-323 SERIES



MAIN FEATURE

- Small Signal Zener Diodes
- SOD-323 Plastic-Encapsulate Diodes
- Total power dissipation: Max. 300mW.
- Planar die construction
- General purpose and medium current
- Wide Zener reverse voltage range 2.0V to 75V.
- Small plastic package suitable for surface mounted design.
- Tolerance approximately $\pm 5\%$

APPLICATION

- For SMD application

RFQ

[Request For Quotation](#)

PART CODE GUIDE

SOD323	C15S	S	0WJ
1	2	3	4

1) **SOD323**: SMD Zener Diodes, SOD-323 series

2) **C15S**: Type code for original part number BZT52C15S

3) **S**: Package code, Tape/reel, 3000pcs/reel.

4) **0WJ**: Marking code for "WJ" on the case surface, Different Marking for different specification.

SMD ZENER DIODES SOD-323 SERIES

MORE ITEMS AVAILABLE

SOD3232V0SS0WY	SOD3232V2SS0WZ	SOD3232V4SS0WX		
SOD3232V7SS0WX	SOD3233V0SS0W2	SOD3233V3SS0W3	SOD3233V6SS0W4	SOD3233V9SS0W5
SOD3234V3SS0W6	SOD3234V7SS0W7	SOD3235V1SS0W8	SOD3235V6SS0W9	
SOD3236V2SS0WA	SOD3236V8SS0WB	SOD323C7V5S0WC	SOD3238V2SS0WD	SOD3239V1SS0WE
SOD323C10SS0WF	SOD323C11SS0WG	SOD323C12SS0WH	SOD323C13SS0WI	SOD323C15SS0WJ
SOD323C16SS0WK	SOD323C18SS0WL	SOD323C20SS0WM	SOD323C22SS0WN	SOD323C24SS0WO
SOD323C27SS0WP	SOD323C30SS0WQ	SOD323C33SS0WR	SOD323C36SS0WS	SOD323C39SS0WT
SODS23C43SS0WU	SOD323C47SS0WV	SOD323C51SS0WW	SOD323C56SS0VW	
SOD323C62SS06E	SOD323C68SS06F	SOD323C75SS06H		

SMD ZENER DIODES SOD-323 SERIES

DIMENSION (Unit: Inch/mm)

Image for reference



Marking: WJ

SOD-323

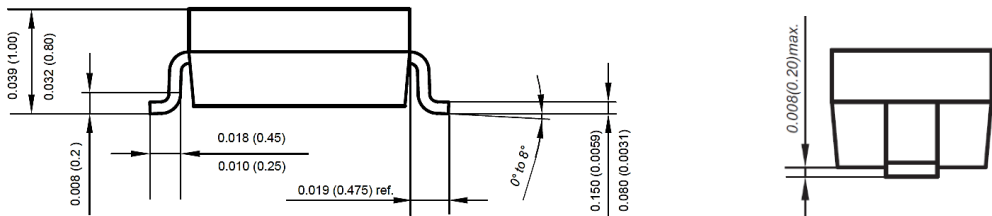
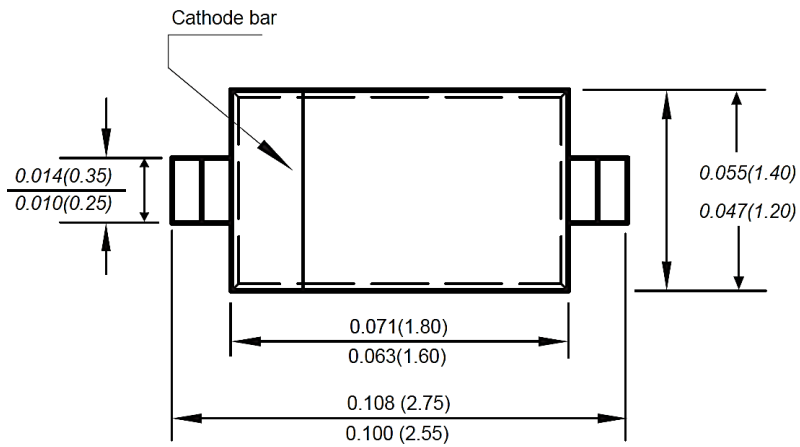

Recommend Pad Layout

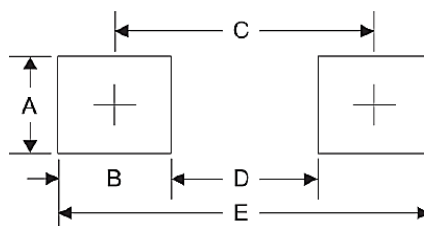

Symbol	Unit (inch)	Unit (mm)
A	0.028	0.70
B	0.028	0.70
C	0.085	2.15
D	0.071	1.80
E	0.112	2.85

SMD ZENER DIODES SOD-323 SERIES
MECHANICAL DATA

Case	Terminals	Polarity	Mounting Position	Weight per piece
JEDEC SOD-323 molded plastic body	Solder plated, Solderable per MIL-STD-750, Method 2026	Polarity symbol marking on case	Any	0.00019 Ounce, 0.0059 grams

MAX. RATING & CHARACTERISTICS - Ratings at 25°C ambient temperature unless otherwise specified.

Parameter	SYMBOLS	VALUE			UNITS
		Min.	Typical	Max.	
Forward Voltage @ IF=10mA (Note 2)	V _F		0.9		V
Power Dissipation (Note 1)	P _d		200		mW
Thermal resistance junction to ambient (See Note 1)	R _{QJA}		417		°C/W
junction temperature	T _J			+150	°C
Storage temperature range	T _{STG}	-55		+150	°C

Note

1. Thermal resistance from junction to ambient at P.C.B. mounted with 2.0" X 2.0" (5 X 5 cm) copper areas pads.
2. Short duration test pulse used to minimize self-heating effect
3. f = 1 kHz

ELECTRICAL CHARACTERISTICS - Ratings at 25°C ambient temperature unless otherwise specified.

Parameter	SYMBOLS	VALUE			UNITS
		Min.	Typical	Max.	
Zenner Voltage Range @I_{ZT}=5.0mA (See Note 1)	V _{ZT}	13.8	15.0	15.6	V
Dynamic Impedance @I_{ZT}=5.0mA	Z _{ZT}			40	Ω
Reverse Current @V_R=11.0V	I _R			0.1	μA

Note

1. V_{ZT} is tested with pulses (20 ms).

SMD ZENER DIODES SOD-323 SERIES

RELIABILITY

Number	Experiment Items	Experiment Method And Conditions	Reference Documents
1	Solder Resistance Test	Test 260°C± 5°C for 10 ± 2 sec. Immerse body into solder 1/16" ± 1/32"	MIL-STD-750D METHOD-2031.2
2	Solderability Test	230°C ±5°C for 5 sec.	MIL-STD-750D METHOD-2026.1 0
3	Pull Test	1 kg in axial lead direction for 10 sec.	MIL-STD-750D METHOD-2036.4
4	Bend Test	0.5Kg Weight Applied To Each Lead, Bending Arcs 90 °C ± 5 °C For 3 Times	MIL-STD-750D METHOD-2036.4
5	High Temperature Reverse Bias Test	TA=100°C for 1000 Hours at VR=80% Rated VR	MIL-STD-750D METHOD-1038.4
6	Forward Operation Life Test	TA=25°C Rated Average Rectified Current	MIL-STD-750D METHOD-1027.3
7	Intermittent Operation Life Test	On state: 5 min with rated IRMS Power Off state: 5 min with Cool Forced Air. On and off for 1000 cycles.	MIL-STD-750D METHOD-1036.3
8	Pressure Cooker Test	15 PSIG, TA=121°C, 4 hours	MIL-S-19500 APPENOIXC
9	Temperature Cycling Test	-55°C~+125°C; 30 Minutes For Dwelled Time 5 minutes for transferred time. Total: 10 cycles.	MIL-STD-750D METHOD-1051.7
10	Thermal Shock Test	0°C for 5 minutes., 100°C for 5minutes, Total: 10 cycles	MIL-STD-750D METHOD-1056.7
11	Forward Surge Test	8.3ms Single Sale Sine-wave One Surge.	MIL-STD-750D METHOD-4066.4
12	Humidity Test	TA=65°C, RH=98% for 1000 hours.	MIL-STD-750D METHOD-1021.3
13	High Temperature Storage life Test	150°C for 1000 Hours	MIL-STD-750D METHOD-1031.5

SUGGESTED REFLOW PROFILE (For Reference Only)

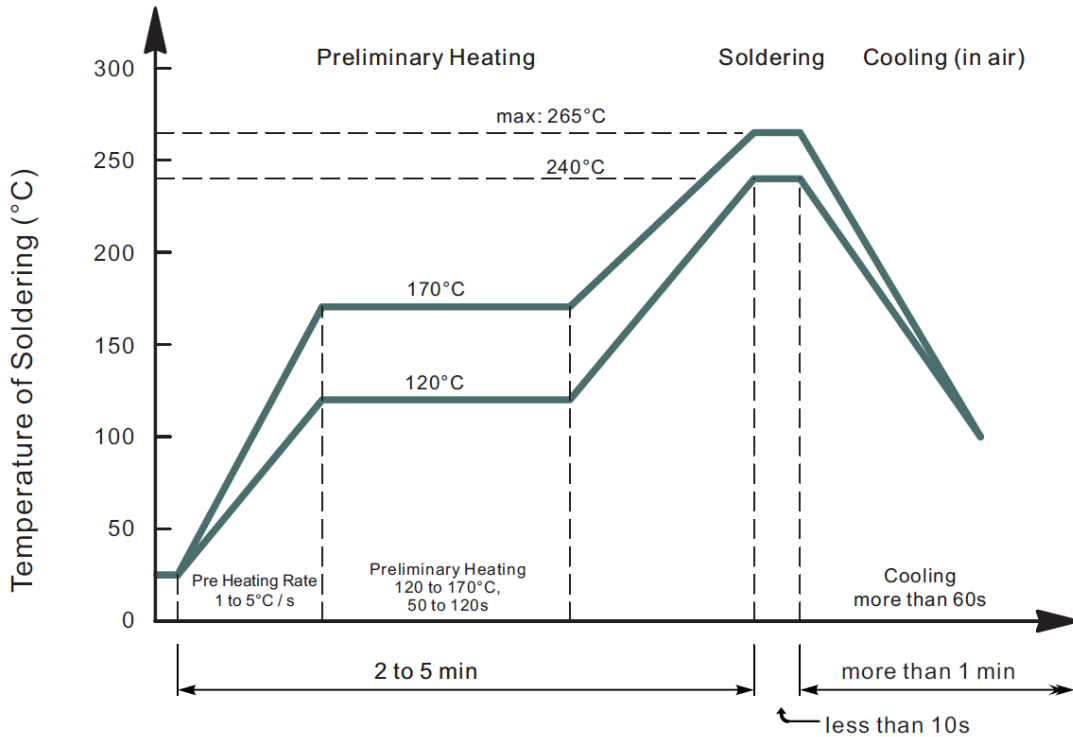

- Recommended peak temperature is over 245°C, If peak temperature is below 245 °C, you may adjust the following parameters; time length of peak temperature (longer), time length of soldering (longer), thickness of solder paste (thicker)
- Welding shall not exceed 2 times
- Remark: lead free solder paste (96.5 sn/3.0 Ag/0.5Cu)

RATINGS AND CHARACTERISTIC CURVES (For Reference Only)

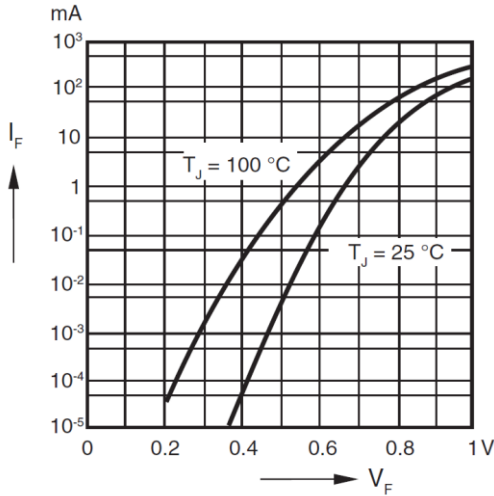

Fig. 1 - Forward characteristics

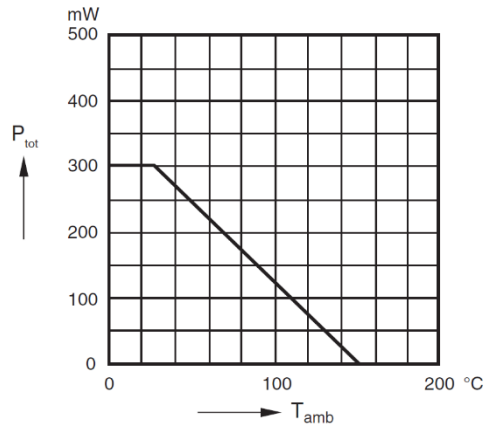

Fig. 2 - Admissible Power Dissipation vs. Ambient Temperature

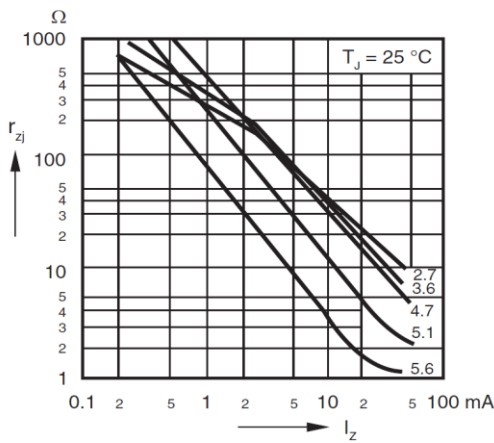

Fig. 3 - Dynamic Resistance vs. Zener Current

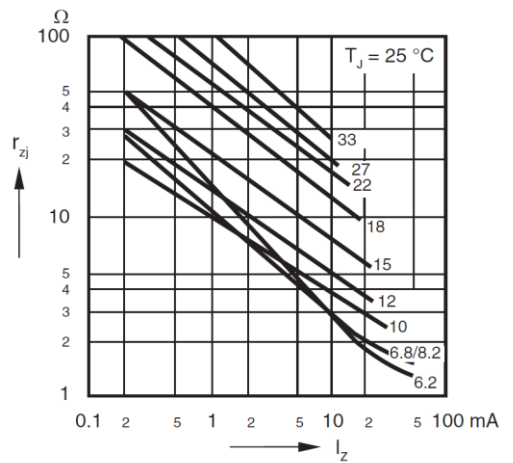

Fig. 4 - Dynamic Resistance vs. Zener Current

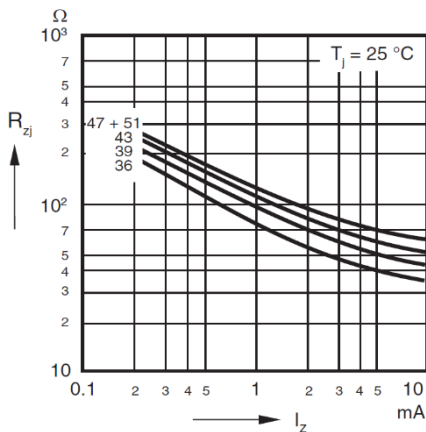

Fig. 5 - Dynamic Resistance vs. Zener Current

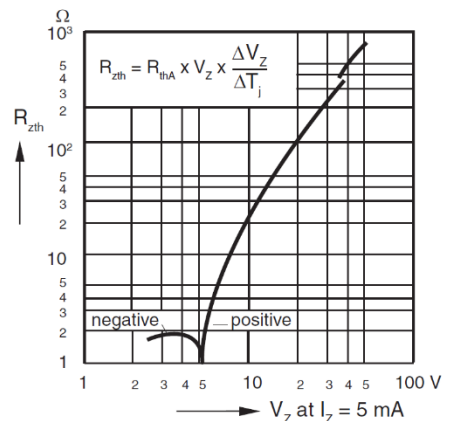

Fig. 6 - Thermal Differential Resistance vs. Zener Voltage

RATINGS AND CHARACTERISTIC CURVES (For Reference Only)

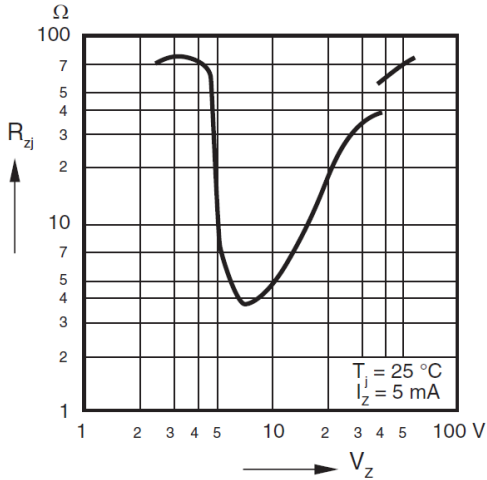

Fig. 7 - Dynamic Resistance vs. Zener Voltage

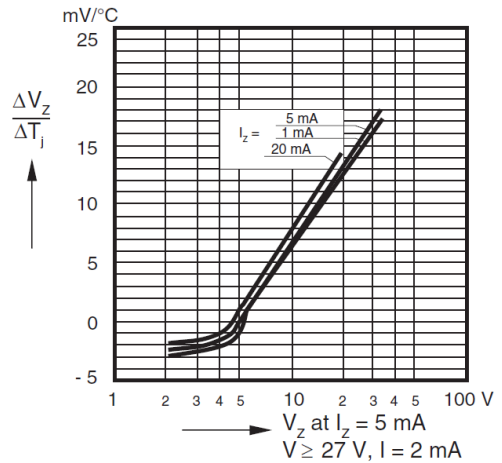

Fig. 8 - Temperature Dependence of Zener Voltage vs. Zener Voltage

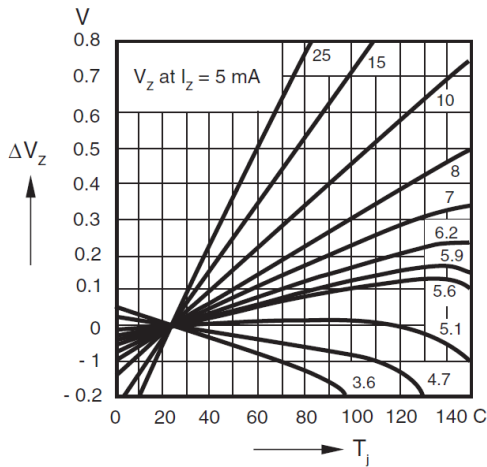

Fig. 9 - Change of Zener Voltage vs. Junction Temperature

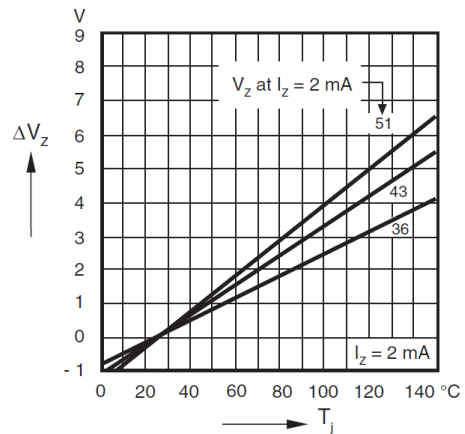

Fig. 10 - Change of Zener Voltage vs. Junction Temperature

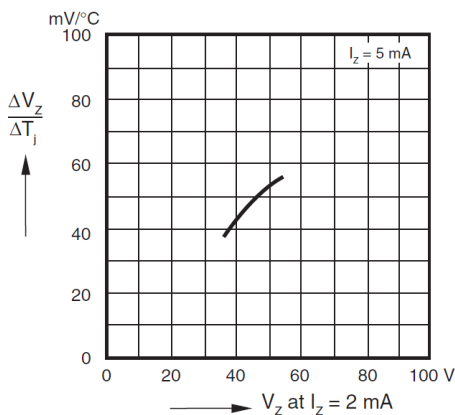

Fig. 11 - Temperature Dependence of Zener Voltage vs. Zener Voltage

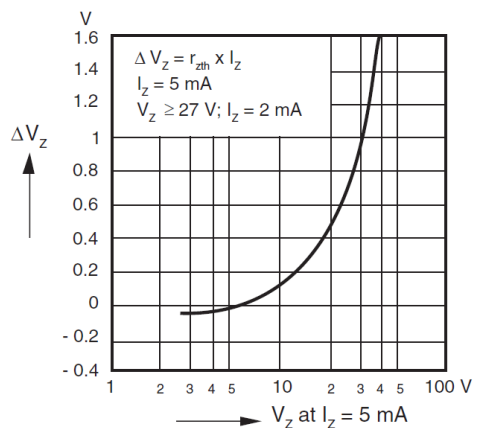

Fig. 12 - Change of Zener Voltage from Turn-on up to the Point of Thermal Equilibrium vs. Zener Voltage

RATINGS AND CHARACTERISTIC CURVES (For Reference Only)

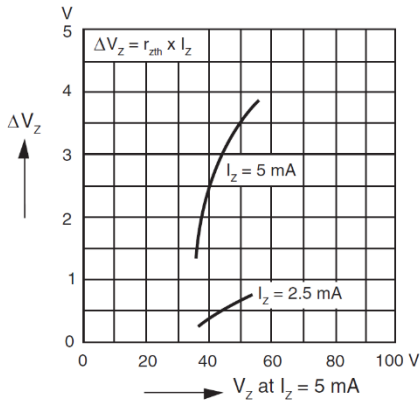

Fig. 13 - Change of Zener Voltage from Turn-on up to the Point of Thermal Equilibrium vs. Zener Voltage

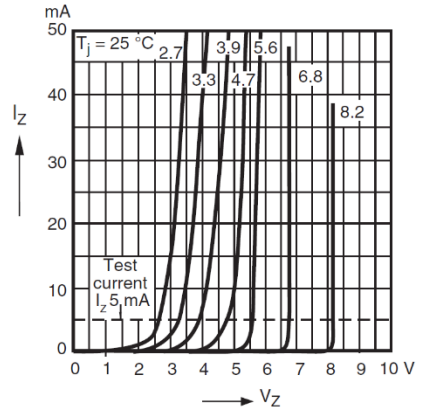

Fig. 14 - Breakdown Characteristics

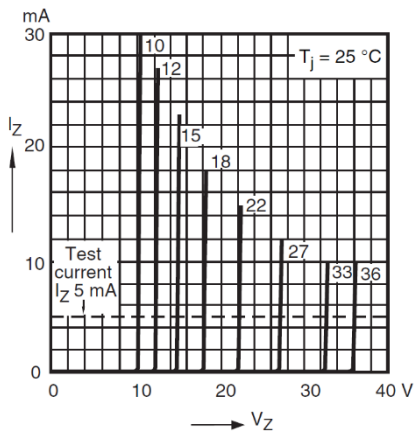

Fig. 15 - Breakdown Characteristics

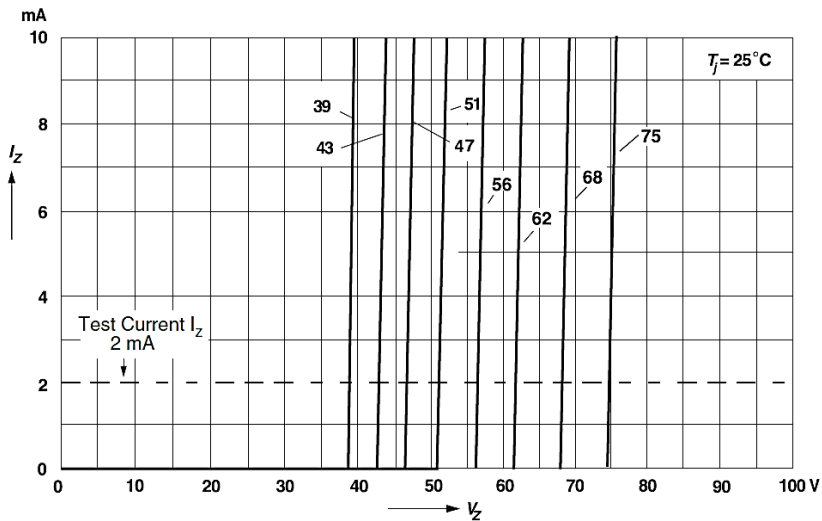
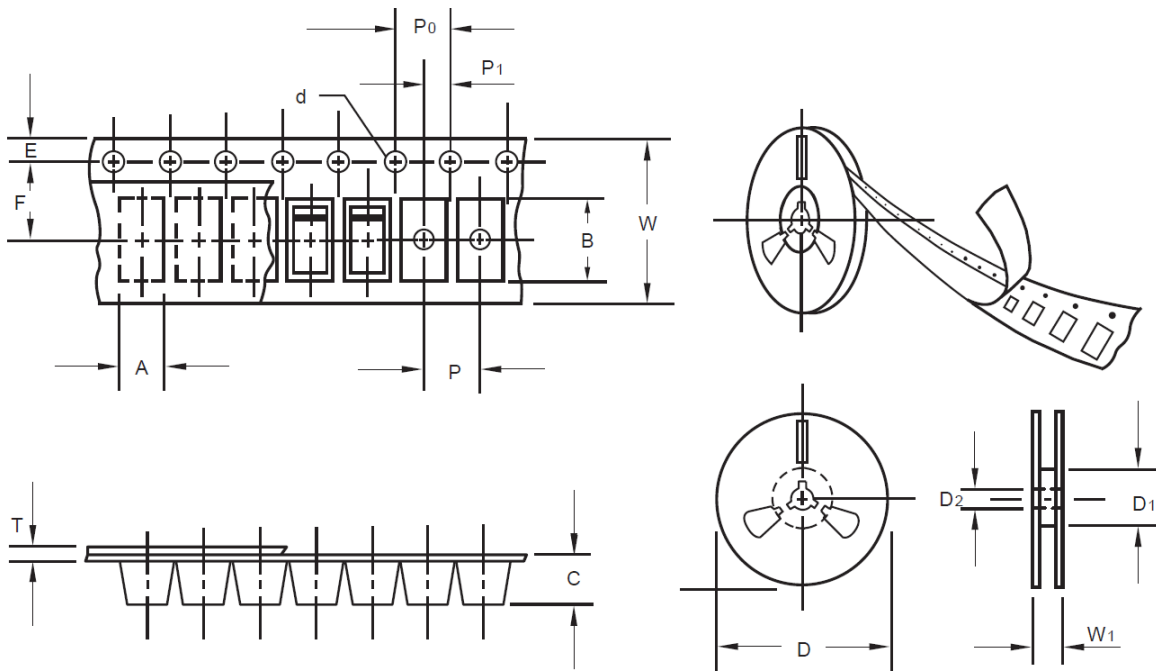

Fig. 16 - Breakdown Characteristics

SMD ZENER DIODES SOD-323 SERIES

TAPE/REEL (Unit: mm)

All Devices are packed in accordance with EIA standard RS-481-A and specifications.



Item	Symbol	Tolerance	SOD-323
Carrier width	A	0.1	2.10
Carrier Length	B	0.1	4.00
Carrier Depth	C	0.1	1.60
Sprocket hole	d	0.05	1.55
13" Reel outside diameter	-	-	-
13" Reel inner diameter	-	-	-
7" Reel outside diameter	D	2.0	178.00
7" Reel inner diameter	D1	Min.	50.00
Feed hole diameter	D2	0.5	13.00
Sprocket hole position	E	0.1	1.75
Punch hole position	F	0.1	3.50
Punch hole pitch	P	0.1	4.00
Sprocket hole pitch	P0	0.1	4.00
Embossment center	P1	0.1	2.00
Overall tape thickness	T	0.1	0.25
Tape width	W	0.3	8.15
Reel width	W1	1.0	10.50

SMD ZENER DIODES SOD-323 SERIES

PACKAGE

Case Code	Reel Size	MPQ (pcs)	Component Spacing (mm)	Qty. Per Box (pcs)	Inner Box L*W*H (mm)	Reel Size (mm)	Carton size L*W*H (mm)	Qty. Per Carton (pcs)	G. W (kg)
SOD-323	7"	3,000	-	24,000	210*208*203	178	400*400*250	180,000	8.0

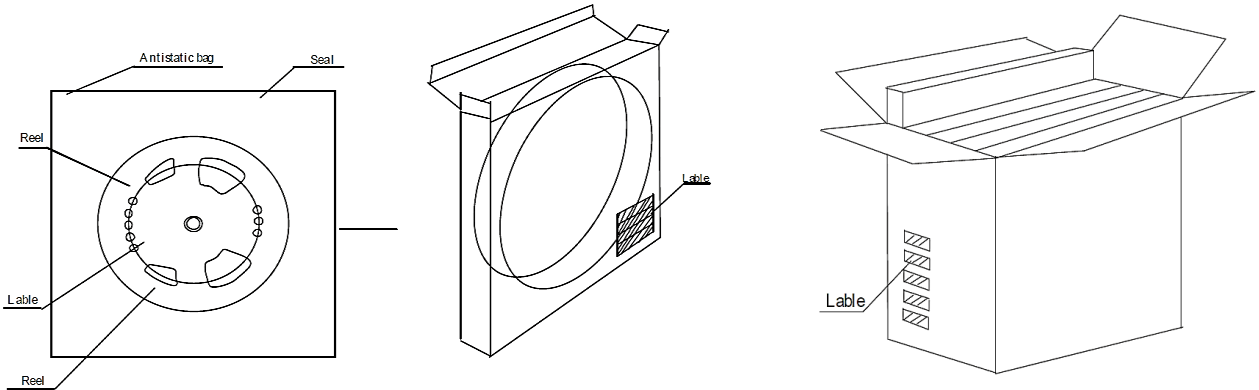

DISCLAIMER

NextGen Component, Inc. reserves the right to make changes to the product(s) and or information contained herein without notice. No liability is assumed as a result of their use or application. No rights under any patent accompany the sale of any such product(s) or information