



**SPECIFICATION SHEET**

<b>SPECIFICATION SHEET NO.</b>	P0610- SOT23S9012S2T1
<b>DATE</b>	June 10, 2022
<b>REVISION</b>	A0
<b>DESCRIPTION</b>	SMD Plastic-Encapsulate Transistors, SOT-23 series, 3 pads S9012 Type, PNP Collector-Emitter Voltage 25V. Collector Current 0.5A Max. Operating Temp. Range -55°C ~+150°C, Package in Tape/Reel, 3000pcs/Reel RoHS/RoHS III compliant
<b>CUSTOMER</b>	
<b>CUSTOMER PART NUMBER</b>	
<b>CROSS REF. PART NUMBER</b>	
<b>ORIGINAL PART NUMBER</b>	MDD S9012
<b>PART CODE</b>	SOT23S9012S2T1

<b>VENDOR APPROVE</b>			
Issued/Checked/Approved			
DATE: June 10, 2022			

<b>CUSTOMER APPROVE</b>	
DATE:	

6/13/2022

**SMD PLASTIC-ENCAPULATE TRANSISTORS SOT23 SERIES**

**MAIN FEATURE**

- High Collector Current
- Complementary To S9013
- Excellent hFE Linearity



**APPLICATION**

- For PCB Application

**RFQ**

[Request For Quotation](#)

**PART CODE GUIDE**

SOT23	S9012	S	2T1
1	2	3	4

- 1) **SOT23**: SMD Plastic-Encapsulate Transistors, 3 pads SOT-23 series Code
- 2) **S9012**: Type code for S9012 Type
- 3) **S**: Package code, Package in Tape/Reel, 3000pcs/Reel
- 4) **2T1**: Marking code for “2T1” on the case surface, Different Marking for different specification

**SMD PLASTIC-ENCAPULATE TRANSISTORS SOT23 SERIES**

**DIMENSION (Unit: Inch/mm)**

Image for reference

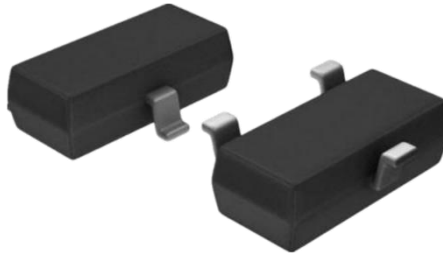

Marking: 2T1

SOT-23

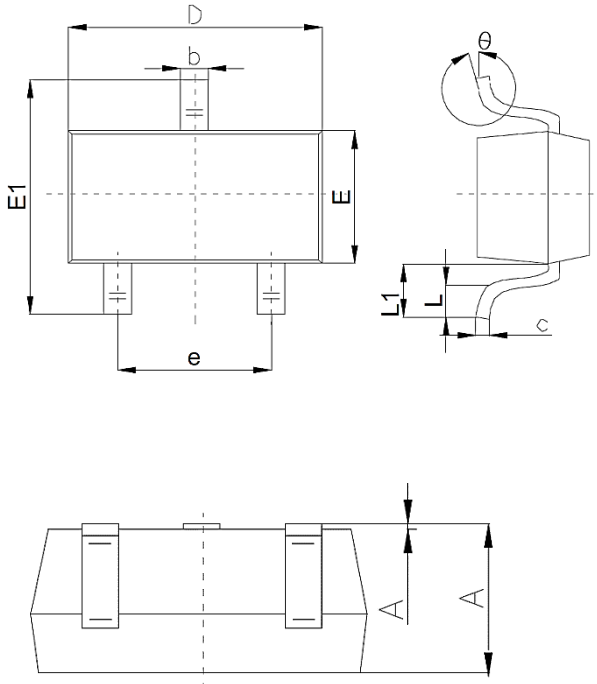

Symbol	Value ( mm )		
	Min.	Typ.	Max.
A	0.90		1.40
A1			0.10
b	0.30		0.50
c	0.08		0.20
D	2.80	2.90	3.10
E	1.20		1.60
E1	2.25		2.80
e	1.80	1.90	2.00
L	0.10		0.50
L1	0.40		0.55
θ	0°		10°

Recommend Pad Layout

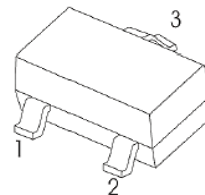
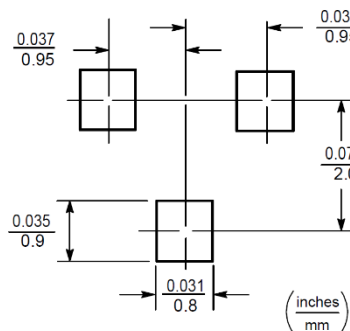

- 1.Base
- 2.Emmitter
- 3.Collector

**SMD PLASTIC-ENCAPULATE TRANSISTORS SOT23 SERIES**
**MECHANICAL DATA**

Case	Terminals	Polarity	Mounting Position	Weight per piece
JEDEC SOT-23 molded plastic body	Solder plated, Solderable per MIL-STD-750, Method 2026	Polarity symbol marking on case	Any	0.00019 Ounce, 0.00591 grams

**MAX. RATINGS AT Ta=25 °C**

Parameter	SYMBOLS	VALUE	UNITS
		LIMIT	
Collector-base Voltage	V <sub>CBO</sub>	-40	Volts
Collector-emitter Voltage	V <sub>CEO</sub>	-25	Volts
Emitter-base Voltage	V <sub>EBO</sub>	-5	Volts
Collector Current - Continuous	I <sub>C</sub>	-0.5	A
Collector Power Dissipation	P <sub>C</sub>	300	mW
Thermal Resistance From Junction To Ambient	R <sub>θJA</sub>	416	°C/W
Junction Temperature	T <sub>J</sub>	+150	°C
Storage Temperature Range	T <sub>STG</sub>	-55 ~ +150	°C

**SMD PLASTIC-ENCAPULATE TRANSISTORS SOT23 SERIES**
**ELECTRICAL CHARACTERISTICS AT Ta= 25 °C**

Parameter	SYMBOLS	VALUE			UNIT	Condition
		Min.	Typ.	Max.		
Collector-base Breakdown Voltage	V <sub>CBO</sub>	-40			V	I <sub>C</sub> = -100 μA, I <sub>E</sub> =0
Collector-emitter Breakdown Voltage	V <sub>CEO</sub>	-25			V	I <sub>C</sub> = -1mA, I <sub>B</sub> =0
Emitter-base Breakdown Voltage	V <sub>EBO</sub>	-5			V	I <sub>E</sub> = -100 μA, I <sub>C</sub> =0
Collector Cut-off Current	I <sub>CBO</sub>			-0.1	μA	V <sub>CB</sub> = -40V, I <sub>E</sub> =0
Collector Cut-off Current	I <sub>CEO</sub>			-0.1	μA	V <sub>CB</sub> =-20V, I <sub>B</sub> =0
Emitter Cut-off Current	I <sub>EBO</sub>			-0.1	μA	V <sub>EB</sub> = -5V, I <sub>C</sub> =0
DC Current Gain	h <sub>FE(1)</sub>	120		400		V <sub>CE</sub> =-1V, I <sub>C</sub> =-50mA
Collector-emitter Saturation Voltage	V <sub>CE(sat)</sub>			-0.6	V	I <sub>C</sub> = -500mA, I <sub>B</sub> =-50mA
Base-emitter Saturation Voltage	V <sub>BE(sat)</sub>			-1.2	V	I <sub>C</sub> =-500mA, I <sub>B</sub> =-50 mA
Transition Frequency	f <sub>T</sub>	150			MHz	V <sub>CE</sub> =-6 V, I <sub>C</sub> = -20mA f= 30 MHz
Collector output capacitance	C <sub>ob</sub>			5	pF	V <sub>CB</sub> =10 V, I <sub>E</sub> =0, f=1 MHz

**CLASSIFICATION OF Hfe (1)**

Rank	L	H	J
Range	120 ~ 200	200 ~ 300	300~400

**SMD PLASTIC-ENCAPULATE TRANSISTORS SOT23 SERIES**
**RELIABILITY**

Number	Experiment Items	Experiment Method And Conditions	Reference Documents
1	Solder Resistance Test	Test 260°C± 5°C for 10 ± 2 sec. Immerse body into solder 1/16" ± 1/32"	MIL-STD-750D METHOD-2031.2
2	Solderability Test	230°C ±5°C for 5 sec.	MIL-STD-750D METHOD-2026.1 0
3	Pull Test	1 kg in axial lead direction for 10 sec.	MIL-STD-750D METHOD-2036.4
4	Bend Test	0.5Kg Weight Applied To Each Lead, Bending Arcs 90 °C ± 5 °C For 3 Times	MIL-STD-750D METHOD-2036.4
5	High Temperature Reverse Bias Test	TA=100°C for 1000 Hours at VR=80% Rated VR	MIL-STD-750D METHOD-1038.4
6	Forward Operation Life Test	TA=25°C Rated Average Rectified Current	MIL-STD-750D METHOD-1027.3
7	Intermittent Operation Life Test	On state: 5 min with rated IRMS Power Off state: 5 min with Cool Forced Air. On and off for 1000 cycles.	MIL-STD-750D METHOD-1036.3
8	Pressure Cooker Test	15 PSIG, TA=121°C, 4 hours	MIL-S-19500 APPENOIXC
9	Temperature Cycling Test	-55°C~+125°C; 30 Minutes For Dwelled Time 5 minutes for transferred time. Total: 10 cycles.	MIL-STD-750D METHOD-1051.7
10	Thermal Shock Test	0°C for 5 minutes., 100°C for 5minutes, Total: 10 cycles	MIL-STD-750D METHOD-1056.7
11	Forward Surge Test	8.3ms Single Sale Sine-wave One Surge.	MIL-STD-750D METHOD-4066.4
12	Humidity Test	TA=65°C, RH=98% for 1000 hours.	MIL-STD-750D METHOD-1021.3
13	High Temperature Storage life Test	150°C for 1000 Hours	MIL-STD-750D METHOD-1031.5

**SMD PLASTIC-ENCAPULATE TRANSISTORS SOT23 SERIES**

**SUGGESTED REFLOW PROFILE (For Reference Only)**

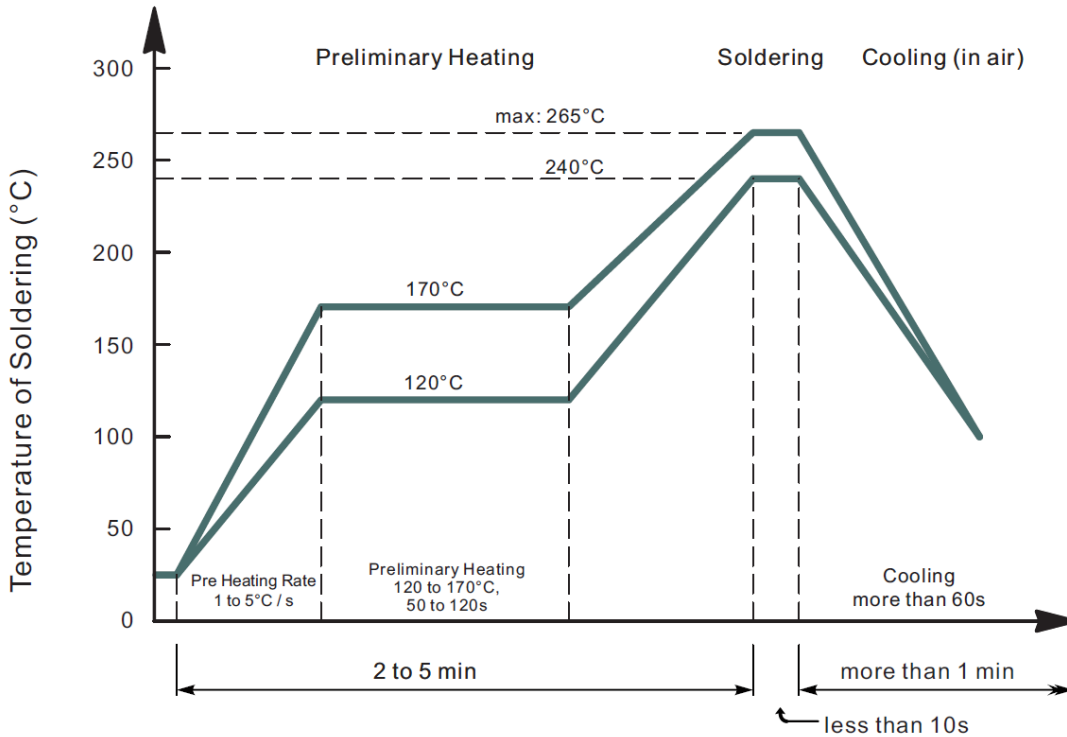

- Recommended peak temperature is over 245°C, If peak temperature is below 245 °C, you may adjust the following parameters; time length of peak temperature (longer), time length of soldering (longer), thickness of solder paste (thicker)
- Welding shall not exceed 2 times
- Remark: lead free solder paste (96.5 sn/3.0 Ag/0.5Cu)

**SMD PLASTIC-ENCCAPULATE TRANSISTORS SOT23 SERIES**

**RATINGS AND CHARACTERISTIC CURVES (For Reference Only)**

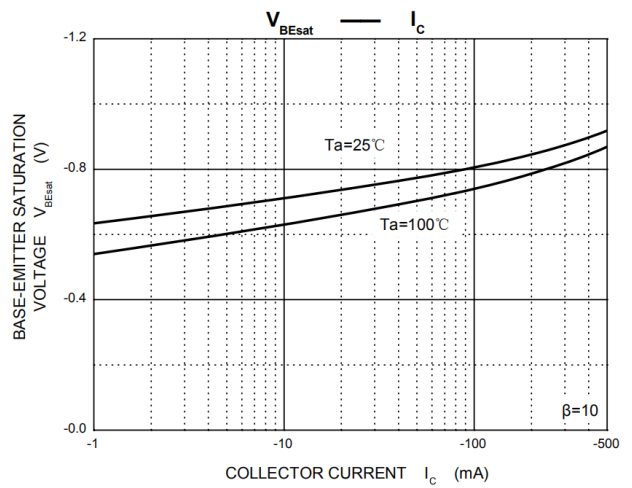
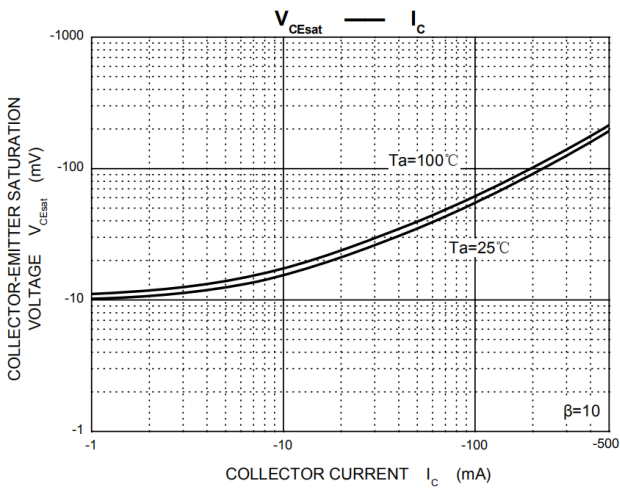
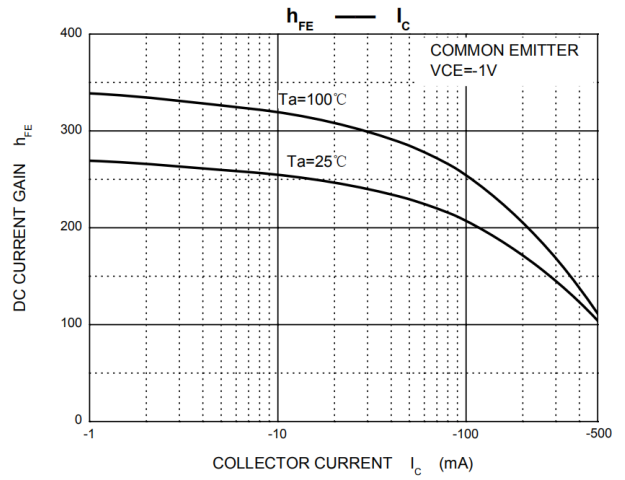
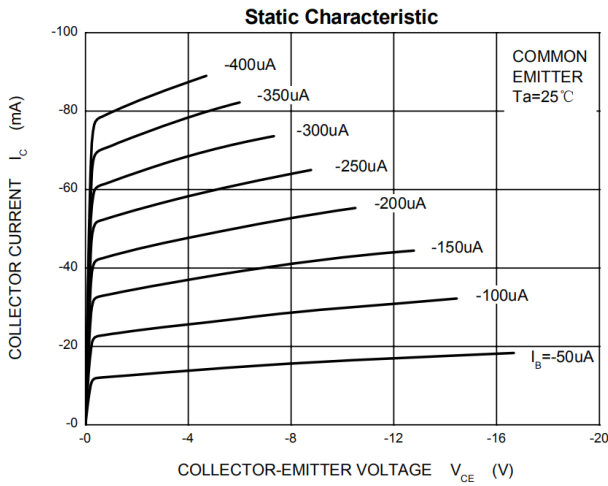



**SMD PLASTIC-ENCAPULATE TRANSISTORS SOT23 SERIES**

**RATINGS AND CHARACTERISTIC CURVES (For Reference Only)**

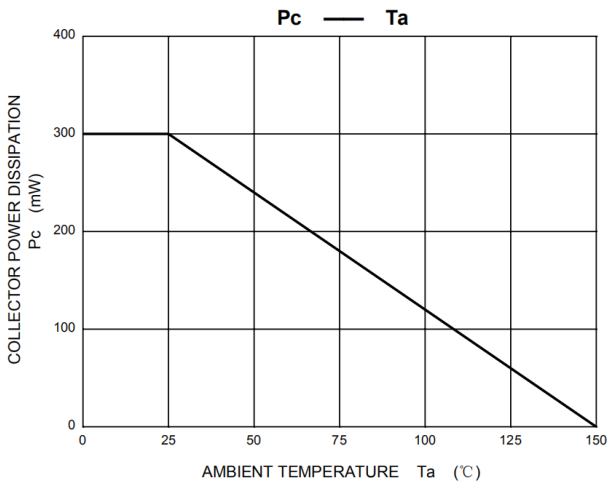
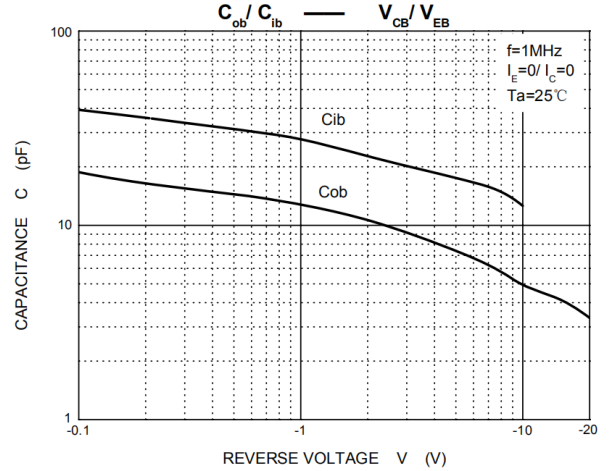
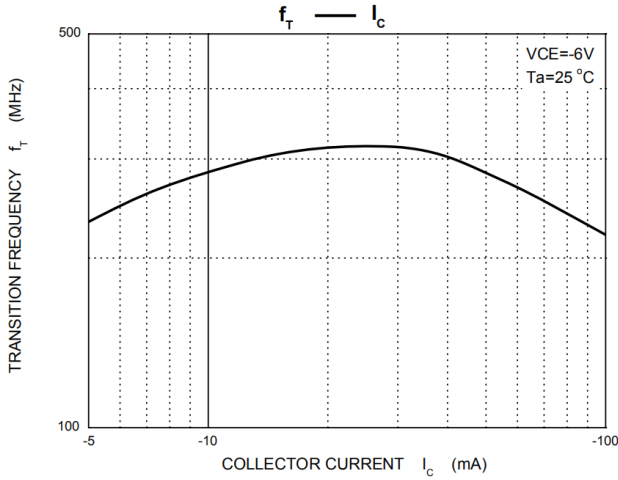

**SMD PLASTIC-ENCAPULATE TRANSISTORS SOT23 SERIES**
**TAPE/REEL (Unit: mm)**

All Devices are packed in accordance with EIA standard RS-481-A and specifications.

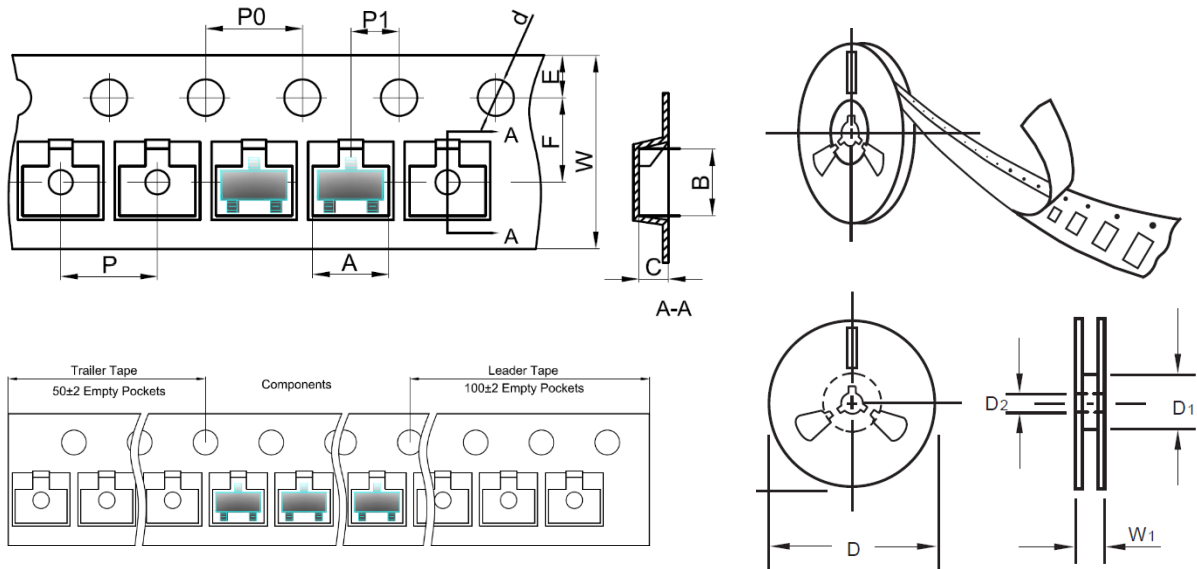

Item	Symbol	Tolerance	SOT-23
Carrier width	A	0.1	3.15
Carrier Length	B	0.1	2.77
Carrier Depth	C	0.1	1.22
Sprocket hole	d	0.05	1.55
7"Reel outside diameter	D	2.0	178.00
7"Reel inner diameter	D1	Min.	54.4
Feed hole diameter	D2	0.5	13.00
Sprocket hole position	E	0.1	1.75
Punch hole position	F	0.1	3.50
Punch hole pitch	P	0.1	4.00
Sprocket hole pitch	P0	0.1	4.00
Embossment center	P1	0.1	2.00
Overall tape thickness	T	0.1	0.25
Tape width	W	0.3	8.00
Reel width	W1	1.0	19.50

**SMD PLASTIC-ENCAPULATE TRANSISTORS SOT23 SERIES**

**PACKAGE**

<b>Case Code</b>	SOT-23
Reel Size	7"
Reel Size	178 mm
MPQ/Reel	3000 pcs
Qty. /Box	6000 pcs
G.W/Box	1 LBS

**DISCLAIMER**

NextGen Component, Inc. reserves the right to make changes to the product(s) and or information contained herein without notice. No liability is assumed as a result of their use or application. No rights under any patent accompany the sale of any such product(s) or information