



**SPECIFICATION SHEET**

<b>SPECIFICATION SHEET NO.</b>	Q0726-SMAP4SMA27AS0A
<b>DATE</b>	July 26, 2023
<b>REVISION</b>	A0
<b>DESCRIPTION</b>	<p>SMD Transient Voltage Suppressor (TVs) Diodes, SMA/DO-214AC series, P4SMA27A Type, 2 Pads, Unidirectional</p> <p><a href="#">Breakdown Voltage (V BR) 27V Average Value.</a></p> <p>Peak Pulse Power: 400 Watts.</p> <p>Operating Temp. Range -55°C ~+150°C</p> <p>Package in Tape/Reel, 5000pcs/13"Reel</p> <p>RoHS/RoHS III compliant</p>
<b>CUSTOMER</b>	
<b>CUSTOMER PART NUMBER</b>	
<b>CROSS REF. PART NUMBER</b>	
<b>ORIGINAL PART NUMBER</b>	MDD P4SMA27A
<b>PART CODE</b>	SMAP4SMA27AS0A

<b>VENDOR APPROVE</b>		
Issued/Checked/Approved		
		
DATE: July 26, 2023		

<b>CUSTOMER APPROVE</b>
DATE:

**SMD TRANSIENT VOLTAGE SUPPRESSORS DIODES SMA SERIES**



**MAIN FEATURE**

- The plastic package carries Underwriters Laboratory Flammability Classification 94V-0
- Low profile package
- Glass Passivated Die Construction
- Low inductance
- 6.8V - 550V Standoff Voltages Average Value
- Excellent clamping capability
- 400W peak pulse power capability at 10/1000µs waveform
- Fast response time

**APPLICATION**

- I/O interface
- AC/DC power supply
- Low frequency signal transmission line (RS232, RS485, etc.)

**RFQ**  
[Request For Quotation](#)

**PART CODE GUIDE**

SMA	P4SMA27A	S0A
1	2	3

- 1) **SMA**: SMD Transient Voltage Suppressor (TVs) Diodes, SMA /DO-214AC series,
- 2) **P4SMA27A**: Type code for original part number P4SMA27A
- 3) **S0A**: Internal Control Code, (A~Z or 1~9 or Blank) or custom parametric data code.

**SMD TRANSIENT VOLTAGE SUPPRESSORS DIODES SMA SERIES**

**DIMENSION (Unit: Inch/mm)**

Image for reference



Marking: standard

\* See Marking Code List

SMA/DO-214AC

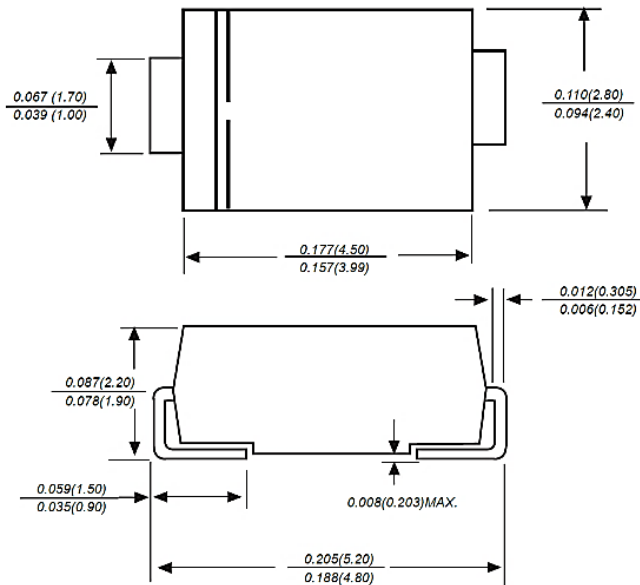

Recommend Pad Layout



Symbol	Unit (Inch)	Unit (mm)
A	0.066	1.680
B	0.060	1.520
C	0.154	3.900
D	0.095	2.410
E	0.215	5.450

**SMD TRANSIENT VOLTAGE SUPPRESSORS DIODES SMA SERIES**

**MECHANICAL DATA**

Case	Terminals	Polarity	Marking	Weight per piece
JEDEC SMA/DO-214AC molded plastic body	Solderable per MIL-STD-750, Method 2026	Cathode Band  (Note: Bi-directional device have no polarity indicator)	See Marking  Code List	0.00095ounce,  0.027grams

**MAX. RATING & CHARACTERISTICS - Ratings at 25°C Ambient Temperature Unless Otherwise Specified.**

Parameter		SYMBOLS	VALUE	UNITS
Peak Pulse Power Dissipation on TA=25°C (Note 1,2,4, Fig1)		P ppm	400	W
Peak Forward Surge Current (Note 3, Fig4 )		I FSM	60	A
Peak Pulse Current on 10/1000 us waveform (Note 1)		I PPM	<i>See Table 1~Table 6</i>	W
ESD Voltage per IEC6100-4-2	Contact	V ESD1	± 30	kV
	Air	V ESD2	± 30	kV
Typical Thermal Resistance Junction to Ambient (Note 2)		R ΘJA	100	°C/W
Operating junction temperature range		T J	-55 ~ +150	°C
Storage temperature range		T stg	-55 ~ +150	°C

Notes

1. Non-repetitive current pulse, per Fig 3 and derated above TA=25 °C per Fig 2
2. Mounted on 5.0\*5.0mm (Thickness 0.03mm) copper pads to each terminal
3. Peak Forward Surge Current : 8.3ms single half sine-wave Superimposed on rated load (JEDEC method).
4. Peak pulse power waveform is 10/1000µS.

**SMD TRANSIENT VOLTAGE SUPPRESSORS DIODES SMA SERIES**
**UNIDIRECTIONAL TYPE- ELECTRICAL CHARACTERISTICS - Ta = 25°C**

Table 1

Part Code	Reverse Stand-off Voltage	Breakdown Voltage		Test Current	Reverse Leakage	Max. Clamp Voltage	Peak Pulse Current	Marking Code
		V BR @ I T						
	V RMV	Min	Max	I T	I R @ V RWM	V C @ I PPM	I PPM	
	V	V	V	mA	µA	V	A	
SMAP4SMA6V8ASA	5.8V	6.45	7.14	10	1000	10.5	39.0	6V8A
SMAP4SMA7V5ASA	6.4	7.13	7.88	10	500	11.3	36.3	7V5A
SMAP4SMA8V2ASA	7.02	7.79	8.61	10	200	12.1	33.9	8V2A
SMAP4SMA9V1ASA	7.78	8.65	9.55	1	50	13.4	30.6	9V1A
SMAP4SMA10AS0A	8.55	9.5	10.5	1	10	14.5	28.3	10A
SMAP4SMA11AS0A	9.4	10.5	11.6	1	5	15.6	26.3	11A
SMAP4SMA12AS0A	10.2	11.4	12.6	1	5	16.7	24.6	12A
SMAP4SMA13AS0A	11.1	12.4	13.7	1	1	18.2	22.5	13A
SMAP4SMA15AS0A	12.8	14.3	15.8	1	1	21.2	19.3	15A
SMAP4SMA16AS0A	13.6	15.2	16.8	1	1	22.5	18.2	16A
SMAP4SMA18AS0A	15.3	17.1	18.9	1	1	25.5	16.1	18A
SMAP4SMA20AS0A	17.1	19	21	1	1	27.7	14.8	20A
SMAP4SMA22AS0A	18.8	20.9	23.1	1	1	30.6	13.4	22A
SMAP4SMA24AS0A	20.5	22.8	25.2	1	1	33.2	12.3	24A
<b>SMAP4SMA27AS0A</b>	<b>23.1</b>	<b>25.7</b>	<b>28.4</b>	<b>1</b>	<b>1</b>	<b>37.5</b>	<b>10.9</b>	<b>27A</b>
SMAP4SMA30AS0A	25.6	28.5	31.5	1	1	41.4	9.9	30A
SMAP4SMA33AS0A	28.2	31.4	34.7	1	1	45.7	9	33A
SMAP4SMA36AS0A	30.8	34.2	37.8	1	1	49.9	8.2	36A
SMAP4SMA39AS0A	33.3	37.1	41	1	1	53.9	7.6	39A

**SMD TRANSIENT VOLTAGE SUPPRESSORS DIODES SMA SERIES**
**UNIDIRECTIONAL TYPE- ELECTRICAL CHARACTERISTICS - Ta = 25°C**

Table 2

Part Code	Reverse Stand-off Voltage	Breakdown Voltage		Test Current	Reverse Leakage	Max. Clamp Voltage	Peak Pulse Current	Marking Code
		V BR @ I T						
	V RMV	Min	Max	I T	I R @ V RWM	V C @ I PPM	I PPM	
	V	V	V	mA	µA	V	A	
SMAP4SMA43AS0A	36.8	40.9	45.2	1	1	59.3	6.9	43A
SMAP4SMA47AS0A	40.2	44.7	49.4	1	1	64.8	6.3	47A
SMAP4SMA51AS0A	43.6	48.5	53.6	1	1	70.1	5.8	51A
SMAP4SMA56AS0A	47.8	53.2	58.8	1	1	77	5.3	56A
SMAP4SMA62AS0A	53	58.9	65.1	1	1	85	4.8	62A
SMAP4SMA68AS0A	58.1	64.6	71.4	1	1	92	4.5	68A
SMAP4SMA75AS0A	64.1	71.3	78.8	1	1	103	4	75A
SMAP4SMA82AS0A	70.1	77.9	86.1	1	1	113	3.6	82A
SMAP4SMA91AS0A	77.8	86.5	95.5	1	1	125	3.3	91A
SMAP4SMA100ASA	85.5	95	105	1	1	137	3	100A
SMAP4SMA110ASA	94	105	116	1	1	152	2.7	110A
SMAP4SMA120ASA	102	114	126	1	1	165	2.5	120A
SMAP4SMA130ASA	111	124	137	1	1	179	2.3	130A
SMAP4SMA150ASA	128	143	158	1	1	207	2	150A
SMAP4SMA160ASA	136	152	168	1	1	219	1.9	160A
SMAP4SMA170ASA	145	162	179	1	1	234	1.8	170A
SMAP4SMA180ASA	154	171	189	1	1	246	1.7	180A
SMAP4SMA200ASA	171	190	210	1	1	274	1.5	200A
SMAP4SMA220ASA	185	209	231	1	1	328	1.3	220A

**SMD TRANSIENT VOLTAGE SUPPRESSORS DIODES SMA SERIES**

**UNIDIRECTIONAL TYPE- ELECTRICAL CHARACTERISTICS - Ta = 25°C**

Table 3

Part Code	Reverse Stand-off Voltage	Breakdown Voltage		Test Current	Reverse Leakage	Max. Clamp Voltage	Peak Pulse Current	Marking Code
		V BR @ I T						
	V RMV	Min	Max	I T	I R @ V RWM	V C @ I PPM	I PPM	
	V	V	V	mA	µA	V	A	
SMAP4SMA250ASA	214	237	263	1	1	344	1.2	250A
SMAP4SMA300ASA	256	285	315	1	1	414	1	300A
SMAP4SMA350ASA	300	332	368	1	1	482	0.9	350A
SMAP4SMA400ASA	342	380	420	1	1	548	0.8	400A
SMAP4SMA440ASA	376	418	462	1	1	602	0.7	440A
SMAP4SMA480ASA	408	456	504	1	1	658	0.6	480A
SMAP4SMA510ASA	434	485	535	1	1	698	0.6	510A
SMAP4SMA530ASA	451	503.5	556.5	1	1	725	0.6	530A
SMAP4SMA540ASA	460	513	567	1	1	740	0.5	540A
SMAP4SMA550ASA	468	522.5	577.5	1	1	760	0.5	550A

**SMD TRANSIENT VOLTAGE SUPPRESSORS DIODES SMA SERIES**
**BIDIRECTIONAL TYPE- ELECTRICAL CHARACTERISTICS - Ta = 25°C**

Table 4

Part Code	Reverse Stand-off Voltage	Breakdown Voltage		Test Current	Reverse Leakage	Max. Clamp Voltage	Peak Pulse Current	Marking Code
		V BR @ I T						
	V RMV	Min	Max	I T	I R @ V RWM	V C @ I PPM	I PPM	
	V	V	V	mA	µA	V	A	
SMAP4SMA6V8CAC	5.8V	6.45	7.14	10	1000	10.5	39.0	6V8C
SMAP4SMA7V5CAC	6.4	7.13	7.88	10	500	11.3	36.3	7V5C
SMAP4SMA8V2CAC	7.02	7.79	8.61	10	200	12.1	33.9	8V2C
SMAP4SMA9V1CAC	7.78	8.65	9.55	1	50	13.4	30.6	9V1C
SMAP4SMA10CASC	8.55	9.5	10.5	1	10	14.5	28.3	10C
SMAP4SMA11CASC	9.4	10.5	11.6	1	5	15.6	26.3	11C
SMAP4SMA12CASC	10.2	11.4	12.6	1	5	16.7	24.6	12C
SMAP4SMA13CASC	11.1	12.4	13.7	1	1	18.2	22.5	13C
SMAP4SMA15CASC	12.8	14.3	15.8	1	1	21.2	19.3	15C
SMAP4SMA16CASC	13.6	15.2	16.8	1	1	22.5	18.2	16C
SMAP4SMA18CASC	15.3	17.1	18.9	1	1	25.5	16.1	18C
SMAP4SMA20CASC	17.1	19	21	1	1	27.7	14.8	20C
SMAP4SMA22CASC	18.8	20.9	23.1	1	1	30.6	13.4	22C
SMAP4SMA24CASC	20.5	22.8	25.2	1	1	33.2	12.3	24C
SMAP4SMA27CASC	23.1	25.7	28.4	1	1	37.5	10.9	27C
SMAP4SMA30CASC	25.6	28.5	31.5	1	1	41.4	9.9	30C
SMAP4SMA33CASC	28.2	31.4	34.7	1	1	45.7	9	33C
SMAP4SMA36CASC	30.8	34.2	37.8	1	1	49.9	8.2	36C
SMAP4SMA39CASC	33.3	37.1	41	1	1	53.9	7.6	39C



**SMD TRANSIENT VOLTAGE SUPPRESSORS DIODES SMA SERIES**

**BIDIRECTIONAL TYPE- ELECTRICAL CHARACTERISTICS - Ta = 25°C**

Table 5

Part Code	Reverse Stand-off Voltage	Breakdown Voltage		Test Current	Reverse Leakage	Max. Clamp Voltage	Peak Pulse Current	Marking Code
		V BR @ I T						
	V RMV	Min	Max	I T	I R @ V RWM	V C @ I PPM	I PPM	
	V	V	V	mA	µA	V	A	
SMAP4SMA43CASC	36.8	40.9	45.2	1	1	59.3	6.9	43AC
SMAP4SMA47CASC	40.2	44.7	49.4	1	1	64.8	6.3	47C
SMAP4SMA51CASC	43.6	48.5	53.6	1	1	70.1	5.8	51C
SMAP4SMA56CASC	47.8	53.2	58.8	1	1	77	5.3	56C
SMAP4SMA62CASC	53	58.9	65.1	1	1	85	4.8	62C
SMAP4SMA68CASC	58.1	64.6	71.4	1	1	92	4.5	68C
SMAP4SMA75CASC	64.1	71.3	78.8	1	1	103	4	75C
SMAP4SMA82CASC	70.1	77.9	86.1	1	1	113	3.6	82C
SMAP4SMA91CASC	77.8	86.5	95.5	1	1	125	3.3	91C
SMAP4SMA100CAC	85.5	95	105	1	1	137	3	100C
SMAP4SMA110CAC	94	105	116	1	1	152	2.7	110C
SMAP4SMA120CAC	102	114	126	1	1	165	2.5	120C
SMAP4SMA130CAC	111	124	137	1	1	179	2.3	130C
SMAP4SMA150CAC	128	143	158	1	1	207	2	150C
SMAP4SMA160CAC	136	152	168	1	1	219	1.9	160C
SMAP4SMA170CAC	145	162	179	1	1	234	1.8	170C
SMAP4SMA180CAC	154	171	189	1	1	246	1.7	180C
SMAP4SMA200CAC	171	190	210	1	1	274	1.5	200C
SMAP4SMA220CAC	185	209	231	1	1	328	1.3	220C

**SMD TRANSIENT VOLTAGE SUPPRESSORS DIODES SMA SERIES**

**BIDIRECTIONAL TYPE- ELECTRICAL CHARACTERISTICS - Ta = 25°C**

Table 6

Part Code	Reverse Stand-off Voltage	Breakdown Voltage		Test Current	Reverse Leakage	Max. Clamp Voltage	Peak Pulse Current	Marking Code
		V BR @ I T						
	V RMV	Min	Max	I T	I R @ V RWM	V C @ I PPM	I PPM	
	V	V	V	mA	µA	V	A	
SMAP4SMA250CAC	214	237	263	1	1	344	1.2	250C
SMAP4SMA300CAC	256	285	315	1	1	414	1	300C
SMAP4SMA350CAC	300	332	368	1	1	482	0.9	350C
SMAP4SMA400CAC	342	380	420	1	1	548	0.8	400C
SMAP4SMA440CAC	376	418	462	1	1	602	0.7	440C
SMAP4SMA480CAC	408	456	504	1	1	658	0.6	480C
SMAP4SMA510CAC	434	485	535	1	1	698	0.6	510C
SMAP4SMA530CAC	451	503.5	556.5	1	1	725	0.6	530C
SMAP4SMA540CAC	460	513	567	1	1	740	0.5	540C
SMAP4SMA550CAC	468	522.5	577.5	1	1	760	0.5	550C

**SMD TRANSIENT VOLTAGE SUPPRESSORS DIODES SMA SERIES**
**RELIABILITY**

Number	Experiment Items	Experiment Method And Conditions	Reference Documents
1	Solder Resistance Test	Test 260°C± 5°C for 10 ± 2 sec. Immerse body into solder 1/16" ± 1/32"	MIL-STD-750D METHOD-2031.2
2	Solderability Test	230°C ±5°C for 5 sec.	MIL-STD-750D METHOD-2026.1 0
3	Pull Test	1 kg in axial lead direction for 10 sec.	MIL-STD-750D METHOD-2036.4
4	Bend Test	0.5Kg Weight Applied To Each Lead, Bending Arcs 90 °C ± 5 °C For 3 Times	MIL-STD-750D METHOD-2036.4
5	High Temperature Reverse Bias Test	TA=100°C for 1000 Hours at VR=80% Rated VR	MIL-STD-750D METHOD-1038.4
6	Forward Operation Life Test	TA=25°C Rated Average Rectified Current	MIL-STD-750D METHOD-1027.3
7	Intermittent Operation Life Test	On state: 5 min with rated IRMS Power Off state: 5 min with Cool Forced Air. On and off for 1000 cycles.	MIL-STD-750D METHOD-1036.3
8	Pressure Cooker Test	15 PSIG, TA=121°C, 4 hours	MIL-S-19500 APPENOIXC
9	Temperature Cycling Test	-55°C~+125°C; 30 Minutes For Dwelled Time 5 minutes for transferred time. Total: 10 cycles.	MIL-STD-750D METHOD-1051.7
10	Thermal Shock Test	0°C for 5 minutes., 100°C for 5minutes, Total: 10 cycles	MIL-STD-750D METHOD-1056.7
11	Forward Surge Test	8.3ms Single Sale Sine-wave One Surge.	MIL-STD-750D METHOD-4066.4
12	Humidity Test	TA=65°C, RH=98% for 1000 hours.	MIL-STD-750D METHOD-1021.3
13	High Temperature Storage life Test	150°C for 1000 Hours	MIL-STD-750D METHOD-1031.5

**SMD TRANSIENT VOLTAGE SUPPRESSORS DIODES SMA SERIES**

**SUGGESTED REFLOW PROFILE (For Reference Only)**



<b>Profile Feature</b>		Pb-Free Assembly
<b>Average Ramp-up Rate (<math>T_s</math> Max to <math>T_p</math>)</b>		3°C/second Max
<b>Preheat</b>	<b>Temperature Min (<math>T_s</math> Min.)</b>	150°C
	<b>Temperature Max (<math>T_s</math> Max.)</b>	200°C
	<b>Time (<math>t_s</math> Min. to <math>t_s</math> Max.)</b>	60 ~ 180 seconds
<b>Time maintained above</b>	<b>Temperature (<math>T_L</math>)</b>	217°C
	<b>Time (<math>t_L</math>)</b>	60 ~ 150 seconds
<b>Peak/Classification Temperature (<math>T_p</math>)</b>		260 °C
<b>Time within 5°C of actual Peak Temperature (<math>t_p</math>)</b>		20 ~ 40 seconds
<b>Ramp-down rate</b>		6 °C /Second Max.
<b>Time 25 °C to Peak Temperature</b>		8 minutes Max.
<b>Suggest reflow times</b>		3 Times Max.

**SMD TRANSIENT VOLTAGE SUPPRESSORS DIODES SMA SERIES**

**RATINGS AND CHARACTERISTIC CURVES (For Reference Only) - Ta= 25°C Unless Otherwise Specified**

Figure 1. Peak Pulse Power Rating Curve

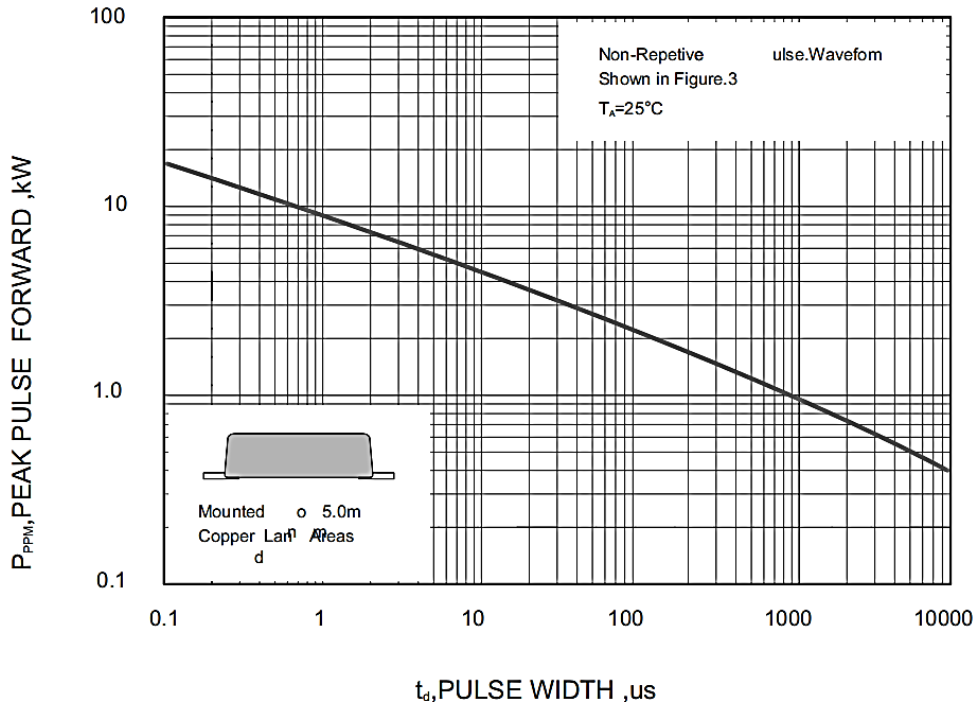
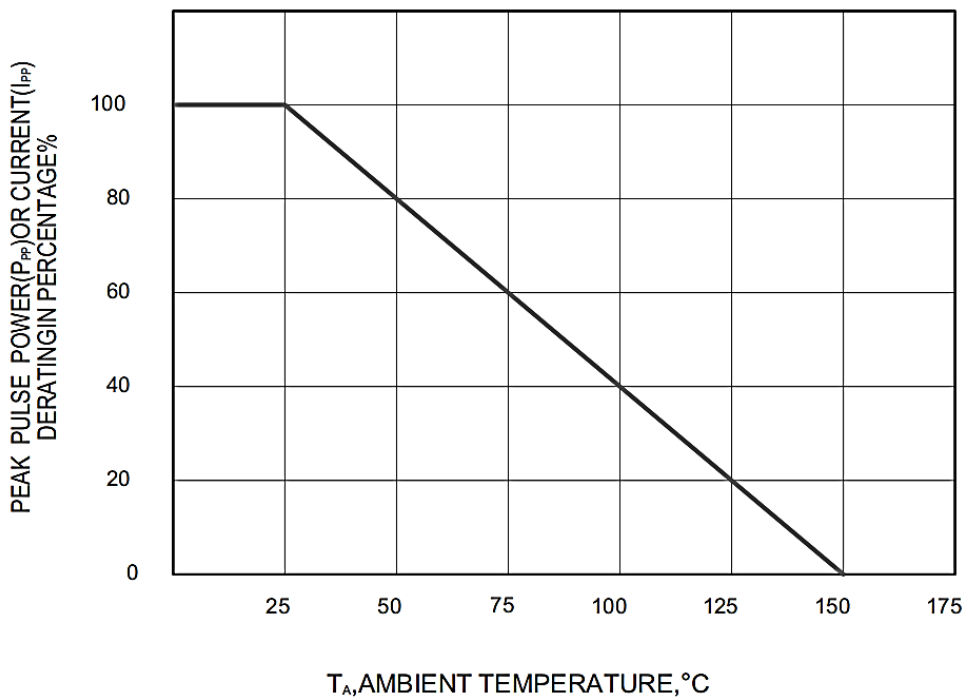

Figure 2. Pulse Derating Curve



**SMD TRANSIENT VOLTAGE SUPPRESSORS DIODES SMA SERIES**

**RATINGS AND CHARACTERISTIC CURVES (For Reference Only) - Ta= 25°C Unless Otherwise Specified**

Figure 3. Pulse Waveform

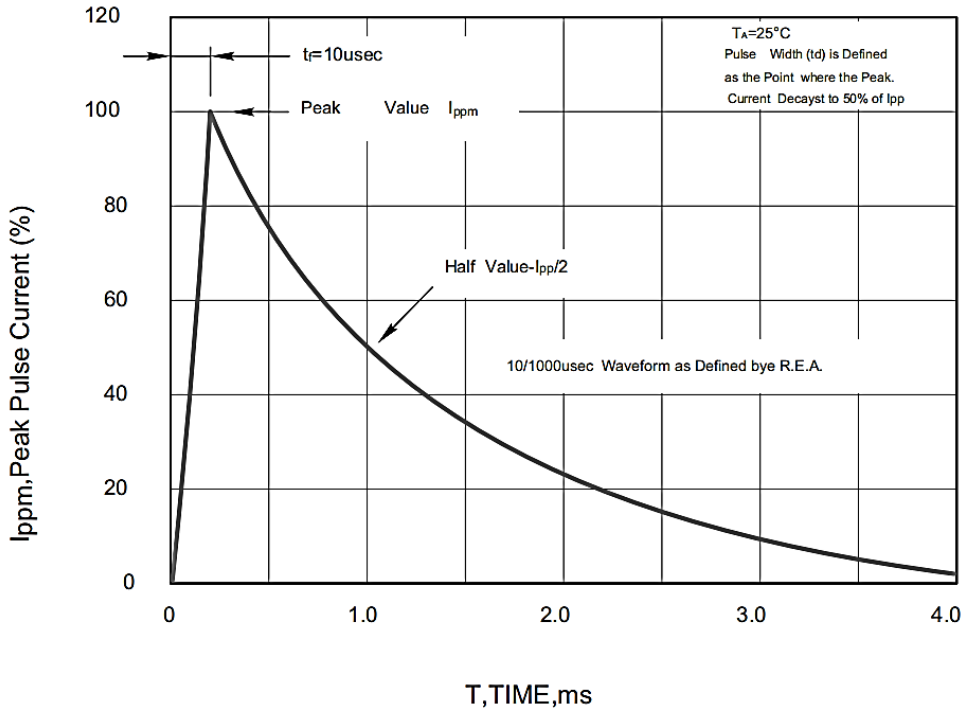
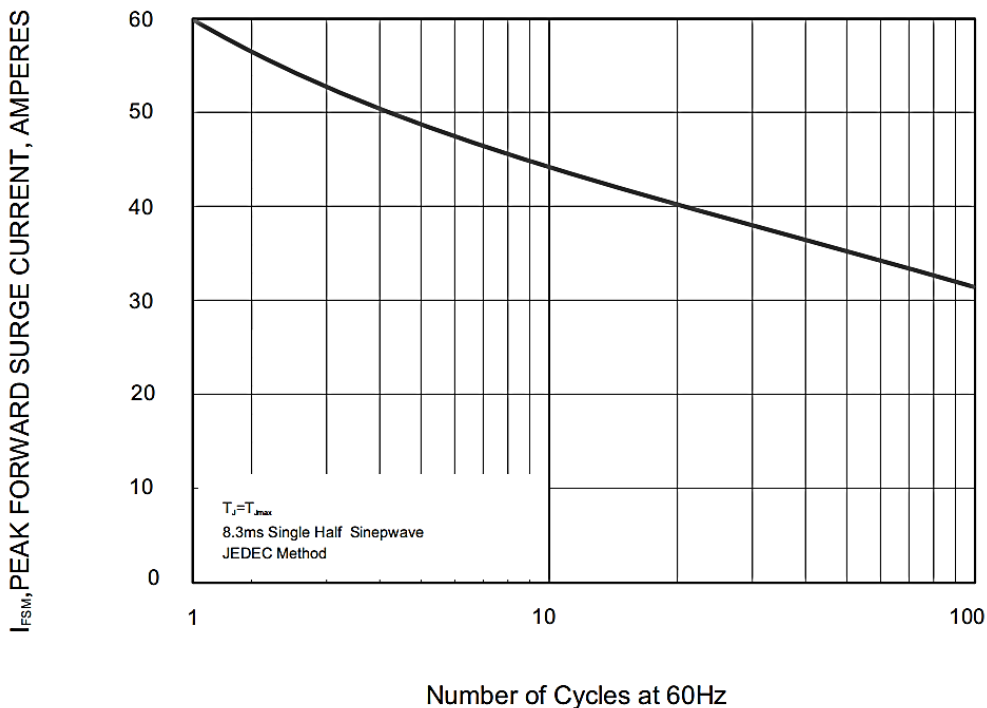

Figure 4. Maximum Non-Repetitive Forward Surge Current



**SMD TRANSIENT VOLTAGE SUPPRESSORS DIODES SMA SERIES**

**TAPE/REEL (Unit: mm)**

All Devices are packed in accordance with EIA standard RS-481-A and specifications.

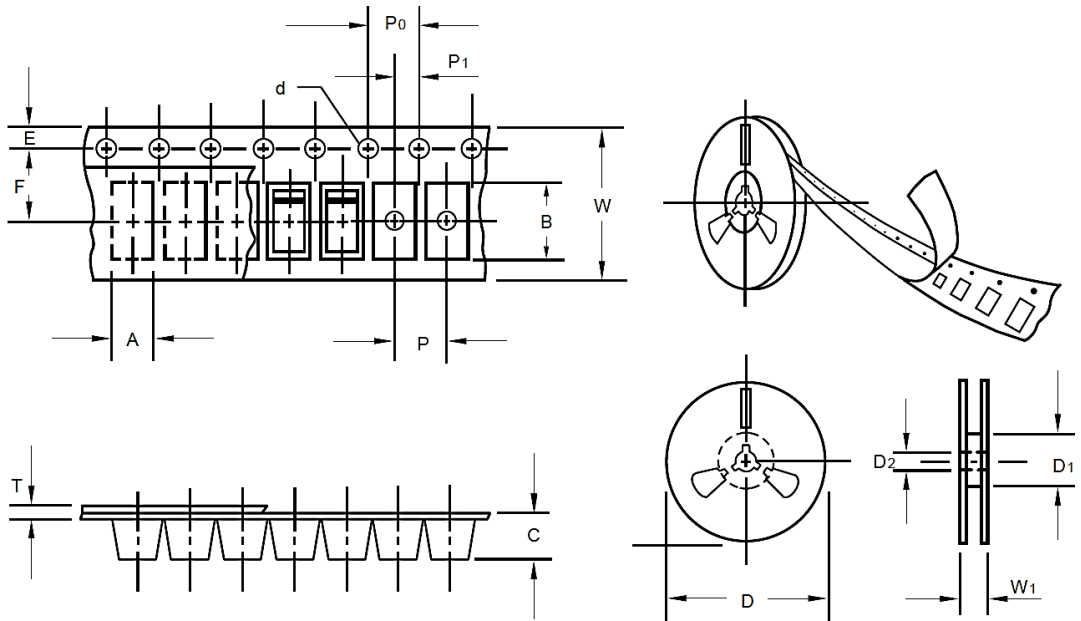

Item	Symbol	Tolerance	SMA/DO-214AC
Carrier width	A	0.1	2.8
Carrier Length	B	0.1	5.33
Carrier Depth	C	0.1	2.36
Sprocket hole	d	0.05	1.50
13"Reel outside diameter	D	2.0	330.0
13"Reel inner diameter	D1	-	50.0Min.
7"Reel outside diameter	D	2.0	178.0
7"Reel inner diameter	D1	-	62.0
Feed hole diameter	D2	0.5	13.00
Sprocket hole position	E	0.1	1.75
Punch hole position	F	0.1	5.50
Punch hole pitch	P	0.1	4.00
Sprocket hole pitch	P0	0.1	4.00
Embossment center	P1	0.1	2.0
Overall tape thickness	T	0.1	0.28
Tape width	W	0.3	12.00
Reel width	W1	1.0	18.0

**SMD TRANSIENT VOLTAGE SUPPRESSORS DIODES SMA SERIES**

**PACKAGE For Reference Only**

Case Code	SMA
Reel Size	13"
Reel Size	330 mm
SPQ/Reel	5000 pcs
Qty. /Box	10000 pcs
G.W/Box	/

**GENERAL RETURN/REFUND POLICY**

NextGen requires that customers first obtain an RMA (Returned Merchandise Authorization) number prior to returning any products. Returns must be made within 30 days of the date of invoice, be in the original packaging, unused and like-new condition. At the time of quoting or purchasing, a product may say that it is Non-Cancelable/Non-Returnable (NCNR). These products are not returnable and not refundable.

**IMPORTANT NOTICE AND DISCLAIMER**

- 1) NextGen Component, Inc. reserves the right to make changes to this document and its products and specifications at any time without notice. Customers should obtain and confirm the latest product information and specifications before final design, purchase or use.
- 2) NextGen Component, Inc makes no warranty, representation or guarantee regarding the suitability of its products for any particular purpose, not does NextGen Component, Inc assume any liability for application assistance or customer product design.
- 3) NextGen Component, Inc does not warrant or accept any liability with products which are purchased or used for any unintended or unauthorized application. No license is granted by implication or otherwise under any intellectual property rights of NextGen Component, Inc
- 4) NextGen Component, Inc. products are not authorized for use as critical components in life support devices or systems without express written approval of NextGen Component, Inc.