



SPECIFICATION SHEET

SPECIFICATION SHEET NO.	Q0801-SMBP6SMB220CAC
DATE	Aug. 01, 2023
REVISION	A0
DESCRIPTION	<p>SMD Transient Voltage Suppressor (TVs) Diodes, SMB/DO-214AA series, P6SMB220CA Type, 2 Pads, Bidirectional</p> <p>Reverse Stand-off Voltage (V R) 185V</p> <p>Peak Pulse Power: 600 Watts.</p> <p>Operating Temp. Range -65°C ~+150°C</p> <p>Package in Tape/Reel, 3000pcs/13"Reel</p> <p>RoHS/RoHS III compliant</p>
CUSTOMER	
CUSTOMER PART NUMBER	
CROSS REF. PART NUMBER	
ORIGINAL PART NUMBER	MDD P6SMB220CA
PART CODE	SMBP6SMB220CAC

VENDOR APPROVE		
Issued/Checked/Approved		
		
DATE: Aug. 01, 2023		

CUSTOMER APPROVE	
DATE:	

SMD TRANSIENT VOLTAGE SUPPRESSORS DIODES SMB SERIES



MAIN FEATURE

- The Plastic Package Carries Underwriters Laboratory Flammability Classification 94V-0
- Low Profile Package
- Glass Passivated Junction
- Low Inductance
- 6.8V - 550V Standoff Voltages Average Value
- Excellent Clamping Capability
- 600W Peak Pulse Power Capability At 10/1000µs Waveform
- Fast Response Time
- Repetition Rate (Duty Cycle): 0.01%
- Typical IR Less Than 1µa Above 12V
- High Temperature Soldering
- Built-in Strain Relief

APPLICATION

- I/O Interface
- AC/DC Power Supply
- Low Frequency Signal Transmission Line (RS232, RS485, etc.)

RFQ

[Request For Quotation](#)

PART CODE GUIDE

SMB	P6SMB220CA	C
1	2	3

- 1) **SMB**: SMD Transient Voltage Suppressor (TVs) Diodes, SMB /DO-214AA series,
- 2) **P6SMB220CA**: Type code for original part number P6SMB220CA
- 3) **C**: Internal Control Code, (A~Z or 1~9 or Blank) or custom parametric data code.

SMD TRANSIENT VOLTAGE SUPPRESSORS DIODES SMB SERIES

DIMENSION (Unit: Inch/mm)

Image for reference



Marking: standard

* See Marking Code List

SMB/DO-214AA

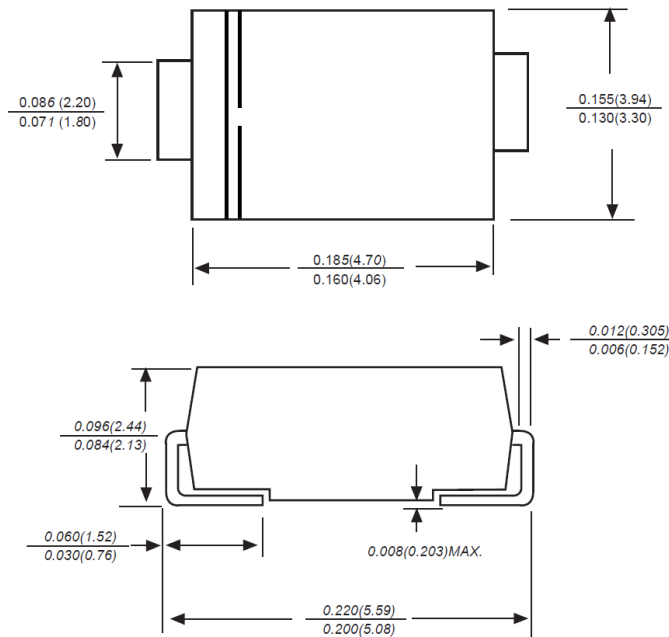

Recommend Pad Layout



Symbol	Unit (inch)	Unit (mm)
A	0.110	2.80
B	0.094	2.40
C	0.181	4.60
D	0.086	2.20
E	0.276	7.00

SMD TRANSIENT VOLTAGE SUPPRESSORS DIODES SMB SERIES

MECHANICAL DATA

Case	Terminals	Polarity	Mounting Position	Marking	Weight per piece
JEDEC SMB/DO-214AA molded plastic body over glass passivated junction	Matte Tin-plated leads, Solderable per JESD22-B102D	Color band denotes cathode except Bidirectional.	Any	See Marking Code List	0.003 ounce, 0.095 grams

MAX. RATING & CHARACTERISTICS - Ratings at 25°C Ambient Temperature Unless Otherwise Specified.

Parameter	SYMBOLS	VALUE	UNITS
Peak Pulse Power Dissipation on TA=25°C by 10x1000µs waveform (Note 1,2, Fig 1)	P ppm	600	W
Peak Forward Surge Current 8.3ms Single Half Sine Wave (Note 3)	I FSM	100	A
Power Dissipation on infinite heat sink at T A=50°C	P M(AV)	5.0	W
Maximum Instantaneous Forward Voltage at 50A for Unidirectional only	V F	3.5/5.0	V
Peak Pulse Current on 10/1000 us waveform (Note 1)	I PPM	<i>See Table 1~Table 6</i>	W
Typical Thermal Resistance Junction (Note 2)	to Ambient	R θJA	100 °C/W
	to Lead	R θJL	20 °C/W
Operating junction temperature range	T J	-65 ~ +150	°C
Storage temperature range	T stg	-65 ~ +150	°C

Notes

1. Non-repetitive current pulse, per Fig 3 and derated above T A=25 °C per Fig 2
2. Mounted on 5.0*5.0mm (0.2 x 0.2") copper pads to each terminal
3. VF<3.5V for devices of VBR<200V and VF<5.0V for devices of VBR>201V

SMD TRANSIENT VOLTAGE SUPPRESSORS DIODES SMB SERIES

UNIDIRECTIONAL TYPE- ELECTRICAL CHARACTERISTICS - Ta = 25°C

Table 1

Part Code	Reverse Stand-off Voltage	Breakdown Voltage		Test Current	Reverse Leakage Max.	Max. Clamp Voltage	Peak Pulse Current	Marking Code
		V BR @ I T						
	V RMV	Min	Max	I T	I R @ V RWM	V C @ I PPM	I PPM	
	V	V	V	mA	µA	V	A	
SMBP6SMB6V8ASA	5.8	6.45	7.14	10	1000	10.5	58.1	6V8A
SMBP6SMB7V5ASA	6.4	7.13	7.88	10	500	11.3	54	7V5A
SMBP6SMB8V2ASA	7.02	7.79	8.61	10	200	12.1	50.4	8V2A
SMBP6SMB9V1ASA	7.78	8.65	9.55	1	50	13.4	45.5	9V1A
SMBP6SMB10AS0A	8.55	9.5	10.5	1	10	14.5	42.1	10A
SMBP6SMB11AS0A	9.4	10.5	11.6	1	5	15.6	39.1	11A
SMBP6SMB12AS0A	10.2	11.4	12.6	1	5	16.7	36.5	12A
SMBP6SMB13AS0A	11.1	12.4	13.7	1	1	18.2	33.5	13A
SMBP6SMB15AS0A	12.8	14.3	15.8	1	1	21.2	28.8	15A
SMBP6SMB16AS0A	13.6	15.2	16.8	1	1	22.5	27.1	16A
SMBP6SMB18AS0A	15.3	17.1	18.9	1	1	25.5	24.2	18A
SMBP6SMB20AS0A	17.1	19	21	1	1	27.7	22	20A
SMBP6SMB22AS0A	18.8	20.9	23.1	1	1	30.6	19.9	22A
SMBP6SMB24AS0A	20.5	22.8	25.2	1	1	33.2	18.4	24A
SMBP6SMB27AS0A	23.1	25.7	28.4	1	1	37.5	16.3	27A
SMBP6SMB30AS0A	25.6	28.5	31.5	1	1	41.4	14.7	30A
SMBP6SMB33AS0A	28.2	31.4	34.7	1	1	45.7	13.3	33A
SMBP6SMB36AS0A	30.8	34.2	37.8	1	1	49.9	12.2	36A
SMBP6SMB39AS0A	33.3	37.1	41	1	1	53.9	11.3	39A

SMD TRANSIENT VOLTAGE SUPPRESSORS DIODES SMB SERIES
UNIDIRECTIONAL TYPE- ELECTRICAL CHARACTERISTICS - Ta = 25°C

Table 2

Part Code	Reverse Stand-off Voltage	Breakdown Voltage		Test Current	Reverse Leakage Max.	Max. Clamp Voltage	Peak Pulse Current	Marking Code
		V BR @ I T						
	V RMV	Min	Max	I T	I R @ V RWM	V C @ I PPM	I PPM	
	V	V	V	mA	µA	V	A	
SMBP6SMB43AS0A	36.8	40.9	45.2	1	1	59.3	10.3	43A
SMBP6SMB47AS0A	40.2	44.7	49.4	1	1	64.8	9.4	47A
SMBP6SMB51AS0A	43.6	48.5	53.6	1	1	70.1	8.7	51A
SMBP6SMB56AS0A	47.8	53.2	58.8	1	1	77	7.9	56A
SMBP6SMB62AS0A	53	58.9	65.1	1	1	85	7.2	62A
SMBP6SMB68AS0A	58.1	64.6	71.4	1	1	92	6.6	68A
SMBP6SMB75AS0A	64.1	71.3	78.8	1	1	103	5.9	75A
SMBP6SMB82AS0A	70.1	77.9	86.1	1	1	113	5.4	82A
SMBP6SMB91AS0A	77.8	86.5	95.5	1	1	125	4.9	91A
SMBP6SMB100ASA	85.5	95	105	1	1	137	4.5	100A
SMBP6SMB110ASA	94	105	116	1	1	152	4	110A
SMBP6SMB120ASA	102	114	126	1	1	165	3.7	120A
SMBP6SMB130ASA	111	124	137	1	1	179	3.4	130A
SMBP6SMB150ASA	128	143	158	1	1	207	2.9	150A
SMBP6SMB160ASA	136	152	168	1	1	219	2.8	160A
SMBP6SMB170ASA	145	162	179	1	1	234	2.6	170A
SMBP6SMB180ASA	154	171	189	1	1	246	2.5	180A
SMBP6SMB200ASA	171	190	210	1	1	274	2.2	200A
SMBP6SMB220ASA	185	209	231	1	1	328	1.9	220A

SMD TRANSIENT VOLTAGE SUPPRESSORS DIODES SMB SERIES

UNIDIRECTIONAL TYPE- ELECTRICAL CHARACTERISTICS - Ta = 25°C

Table 3

Part Code	Reverse Stand-off Voltage	Breakdown Voltage		Test Current	Reverse Leakage Max.	Max. Clamp Voltage	Peak Pulse Current	Marking Code
		V BR @ I T						
	V RMV	Min	Max	I T	I R @ V RWM	V C @ I PPM	I PPM	
	V	V	V	mA	µA	V	A	
SMBP6SMB250ASA	214	237	263	1	1	344	1.8	250A
SMBP6SMB300ASA	256	285	315	1	1	414	1.5	300A
SMBP6SMB350ASA	300	332	368	1	1	482	1.3	350A
SMBP6SMB400ASA	342	380	420	1	1	548	1.1	400A
SMBP6SMB440ASA	376	418	462	1	1	602	1	440A
SMBP6SMB480ASA	408	456	504	1	1	658	0.9	480A
SMBP6SMB510ASA	434	485	535	1	1	698	0.9	510A
SMBP6SMB530ASA	477	503.5	556.5	1	1	725	0.8	530A
SMBP6SMB540ASA	486	513	567	1	1	740	0.8	540A
SMBP6SMB550ASA	495	522.5	577.5	1	1	760	0.8	550A

SMD TRANSIENT VOLTAGE SUPPRESSORS DIODES SMB SERIES
BIDIRECTIONAL TYPE- ELECTRICAL CHARACTERISTICS - Ta = 25°C

Table 4

Part Code	Reverse Stand-off Voltage	Breakdown Voltage		Test Current	Reverse Leakage Max.	Max. Clamp Voltage	Peak Pulse Current	Marking Code
		V BR @ I T						
	V RMV	Min	Max	I T	I R @ V RWM	V C @ I PPM	I PPM	
	V	V	V	mA	µA	V	A	
SMBP6SMB6V8CAC	5.8V	6.45	7.14	10	1000	10.5	58.1	6V8C
SMBP6SMB7V5CAC	6.4	7.13	7.88	10	500	11.3	54	7V5C
SMBP6SMB8V2CAC	7.02	7.79	8.61	10	200	12.1	50.4	8V2C
SMBP6SMB9V1CAC	7.78	8.65	9.55	1	50	13.4	45.5	9V1C
SMBP6SMB10CASC	8.55	9.5	10.5	1	10	14.5	42.1	10C
SMBP6SMB11CASC	9.4	10.5	11.6	1	5	15.6	39.1	11C
SMBP6SMB12CASC	10.2	11.4	12.6	1	5	16.7	36.5	12C
SMBP6SMB13CASC	11.1	12.4	13.7	1	1	18.2	33.5	13C
SMBP6SMB15CASC	12.8	14.3	15.8	1	1	21.2	28.8	15C
SMBP6SMB16CASC	13.6	15.2	16.8	1	1	22.5	27.1	16C
SMBP6SMB18CASC	15.3	17.1	18.9	1	1	25.5	24.2	18C
SMBP6SMB20CASC	17.1	19	21	1	1	27.7	22	20C
SMBP6SMB22CASC	18.8	20.9	23.1	1	1	30.6	19.9	22C
SMBP6SMB24CASC	20.5	22.8	25.2	1	1	33.2	18.4	24C
SMBP6SMB27CASC	23.1	25.7	28.4	1	1	37.5	16.3	27C
SMBP6SMB30CASC	25.6	28.5	31.5	1	1	41.4	14.7	30C
SMBP6SMB33CASC	28.2	31.4	34.7	1	1	45.7	13.3	33C
SMBP6SMB36CASC	30.8	34.2	37.8	1	1	49.9	12.2	36C
SMBP6SMB39CASC	33.3	37.1	41	1	1	53.9	11.3	39C

SMD TRANSIENT VOLTAGE SUPPRESSORS DIODES SMB SERIES

BIDIRECTIONAL TYPE- ELECTRICAL CHARACTERISTICS - Ta = 25°C

Table 5

Part Code	Reverse Stand-off Voltage	Breakdown Voltage		Test Current	Reverse Leakage Max.	Max. Clamp Voltage	Peak Pulse Current	Marking Code
		V BR @ I T						
	V RMV	Min	Max	I T	I R @ V RWM	V C @ I PPM	I PPM	
	V	V	V	mA	µA	V	A	
SMBP6SMB43CASC	36.8	40.9	45.2	1	1	59.3	10.3	43C
SMBP6SMB47CASC	40.2	44.7	49.4	1	1	64.8	9.4	47C
SMBP6SMB51CASC	43.6	48.5	53.6	1	1	70.1	8.7	51C
SMBP6SMB56CASC	47.8	53.2	58.8	1	1	77	7.9	56C
SMBP6SMB62CASC	53	58.9	65.1	1	1	85	7.2	62C
SMBP6SMB68CASC	58.1	64.6	71.4	1	1	92	6.6	68C
SMBP6SMB75CASC	64.1	71.3	78.8	1	1	103	5.9	75C
SMBP6SMB82CASC	70.1	77.9	86.1	1	1	113	5.4	82C
SMBP6SMB91CASC	77.8	86.5	95.5	1	1	125	4.9	91C
SMBP6SMB100CAC	85.5	95	105	1	1	137	4.5	100C
SMBP6SMB110CAC	94	105	116	1	1	152	4	110C
SMBP6SMB120CAC	102	114	126	1	1	165	3.7	120C
SMBP6SMB130CAC	111	124	137	1	1	179	3.4	130C
SMBP6SMB150CAC	128	143	158	1	1	207	2.9	150C
SMBP6SMB160CAC	136	152	168	1	1	219	2.8	160C
SMBP6SMB170CAC	145	162	179	1	1	234	2.6	170C
SMBP6SMB180CAC	154	171	189	1	1	246	2.5	180C
SMBP6SMB200CAC	171	190	210	1	1	274	2.2	200C
SMBP6SMB220CAC	185	209	231	1	1	328	1.9	220C

SMD TRANSIENT VOLTAGE SUPPRESSORS DIODES SMB SERIES

BIDIRECTIONAL TYPE- ELECTRICAL CHARACTERISTICS - Ta = 25°C

Table 6

Part Code	Reverse Stand-off Voltage	Breakdown Voltage		Test Current	Reverse Leakage Max.	Max. Clamp Voltage	Peak Pulse Current	Marking Code
		V BR @ I T						
	V RMV	Min	Max	I T	I R @ V RWM	V C @ I PPM	I PPM	
	V	V	V	mA	µA	V	A	
SMBP6SMB250CAC	214	237	263	1	1	344	1.8	250C
SMBP6SMB300CAC	256	285	315	1	1	414	1.5	300C
SMBP6SMB350CAC	300	332	368	1	1	482	1.3	350C
SMBP6SMB400CAC	342	380	420	1	1	548	1.1	400C
SMBP6SMB440CAC	376	418	462	1	1	602	1	440C
SMBP6SMB480CAC	408	456	504	1	1	658	0.9	480C
SMBP6SMB510CAC	434	485	535	1	1	698	0.9	510C
SMBP6SMB530CAC	477	503.5	556.5	1	1	725	0.8	530C
SMBP6SMB540CAC	486	513	567	1	1	740	0.8	540C
SMBP6SMB550CAC	495	522.5	577.5	1	1	760	0.8	550C

SMD TRANSIENT VOLTAGE SUPPRESSORS DIODES SMB SERIES

RELIABILITY

Number	Experiment Items	Experiment Method And Conditions	Reference Documents
1	Solder Resistance Test	Test 260°C± 5°C for 10 ± 2 sec. Immerse body into solder 1/16" ± 1/32"	MIL-STD-750D METHOD-2031.2
2	Solderability Test	230°C ±5°C for 5 sec.	MIL-STD-750D METHOD-2026.1 0
3	Pull Test	1 kg in axial lead direction for 10 sec.	MIL-STD-750D METHOD-2036.4
4	Bend Test	0.5Kg Weight Applied To Each Lead, Bending Arcs 90 °C ± 5 °C For 3 Times	MIL-STD-750D METHOD-2036.4
5	High Temperature Reverse Bias Test	TA=100°C for 1000 Hours at VR=80% Rated VR	MIL-STD-750D METHOD-1038.4
6	Forward Operation Life Test	TA=25°C Rated Average Rectified Current	MIL-STD-750D METHOD-1027.3
7	Intermittent Operation Life Test	On state: 5 min with rated IRMS Power Off state: 5 min with Cool Forced Air. On and off for 1000 cycles.	MIL-STD-750D METHOD-1036.3
8	Pressure Cooker Test	15 PSIG, TA=121°C, 4 hours	MIL-S-19500 APPENOIXC
9	Temperature Cycling Test	-55°C~+125°C; 30 Minutes For Dwelled Time 5 minutes for transferred time. Total: 10 cycles.	MIL-STD-750D METHOD-1051.7
10	Thermal Shock Test	0°C for 5 minutes., 100°C for 5minutes, Total: 10 cycles	MIL-STD-750D METHOD-1056.7
11	Forward Surge Test	8.3ms Single Sale Sine-wave One Surge.	MIL-STD-750D METHOD-4066.4
12	Humidity Test	TA=65°C, RH=98% for 1000 hours.	MIL-STD-750D METHOD-1021.3
13	High Temperature Storage life Test	150°C for 1000 Hours	MIL-STD-750D METHOD-1031.5

SMD TRANSIENT VOLTAGE SUPPRESSORS DIODES SMB SERIES

SUGGESTED REFLOW PROFILE (For Reference Only)

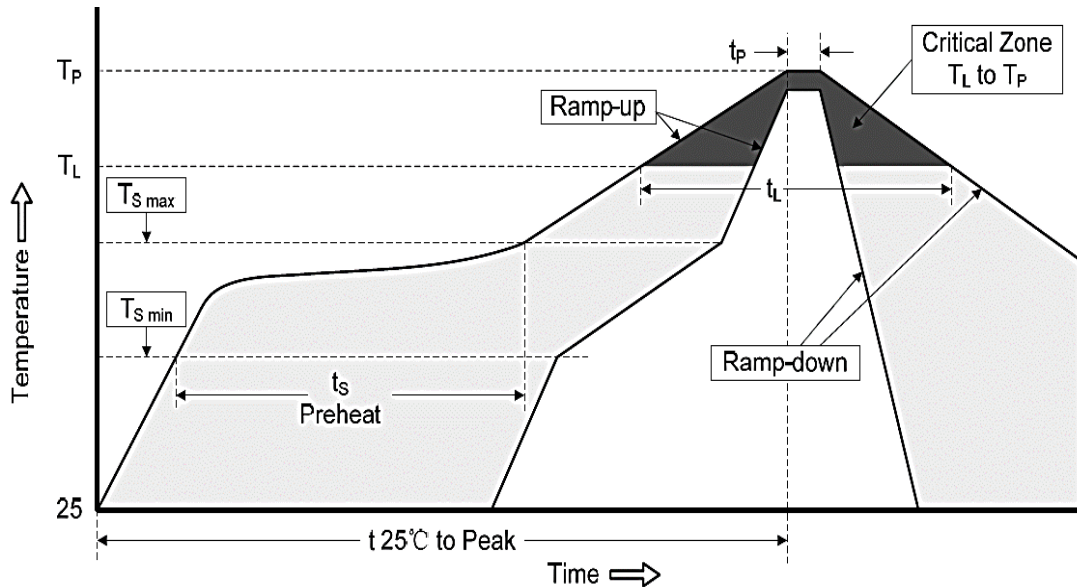

Profile Feature		Pb-Free Assembly
Average Ramp-up Rate (Ts Max to Tp)		3°C/second Max
Preheat	Temperature Min (Ts Min.)	150°C
	Temperature Max (Ts Max.)	200°C
	Time (ts Min. to ts Max.)	60 ~ 180 seconds
Time maintained above	Temperature (Tl)	217°C
	Time (tl)	60 ~ 150 seconds
Peak/Classification Temperature (Tp)		260 °C
Time within 5°C of actual Peak Temperature (tp)		20 ~ 40 seconds
Ramp-down rate		6 °C /Second Max.
Time 25 °C to Peak Temperature		8 minutes Max.
Suggest reflow times		3 Times Max.

SMD TRANSIENT VOLTAGE SUPPRESSORS DIODES SMB SERIES

RATINGS AND CHARACTERISTIC CURVES (For Reference Only) - Ta= 25°C Unless Otherwise Specified

Figure 1. Peak Pulse Power Rating Curve

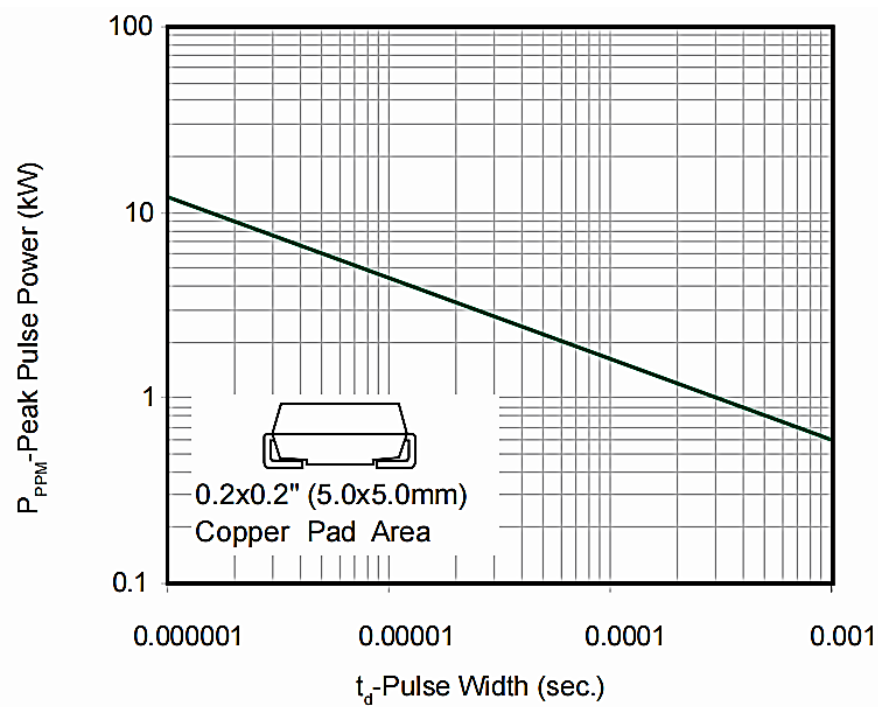
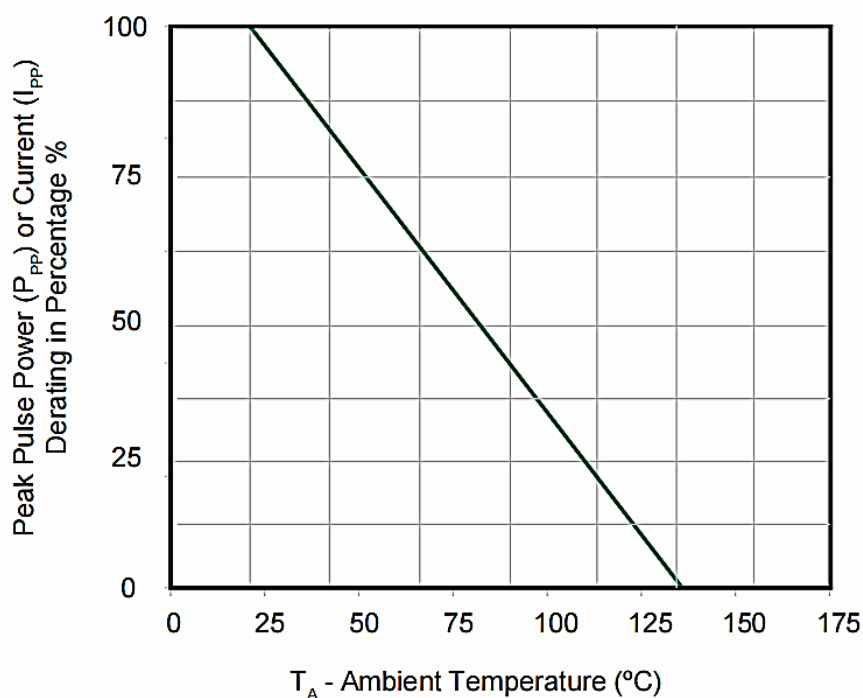

Figure 2. Pulse Derating Curve



SMD TRANSIENT VOLTAGE SUPPRESSORS DIODES SMB SERIES

RATINGS AND CHARACTERISTIC CURVES (For Reference Only) - Ta= 25°C Unless Otherwise Specified

Figure 3. Pulse Waveform

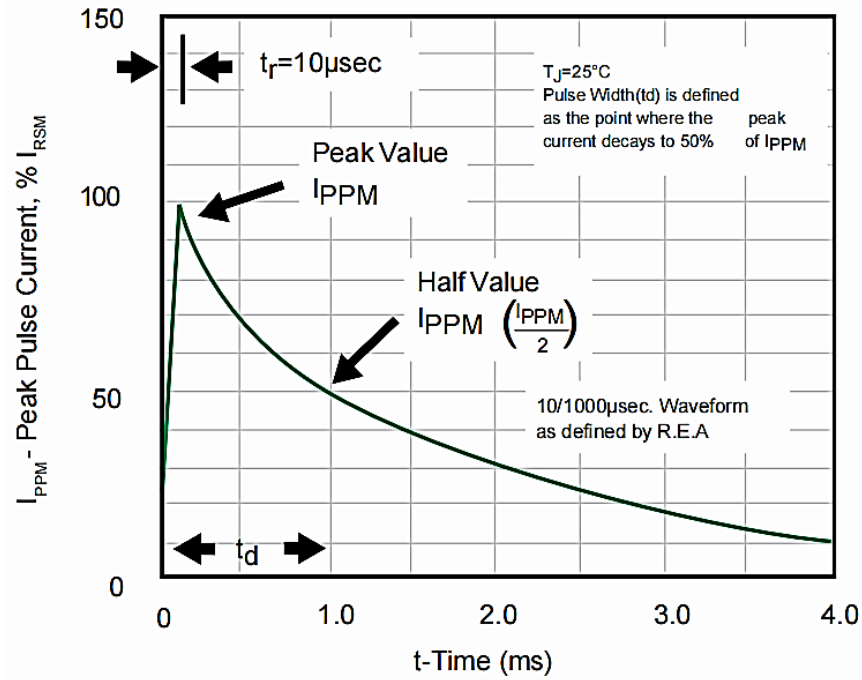
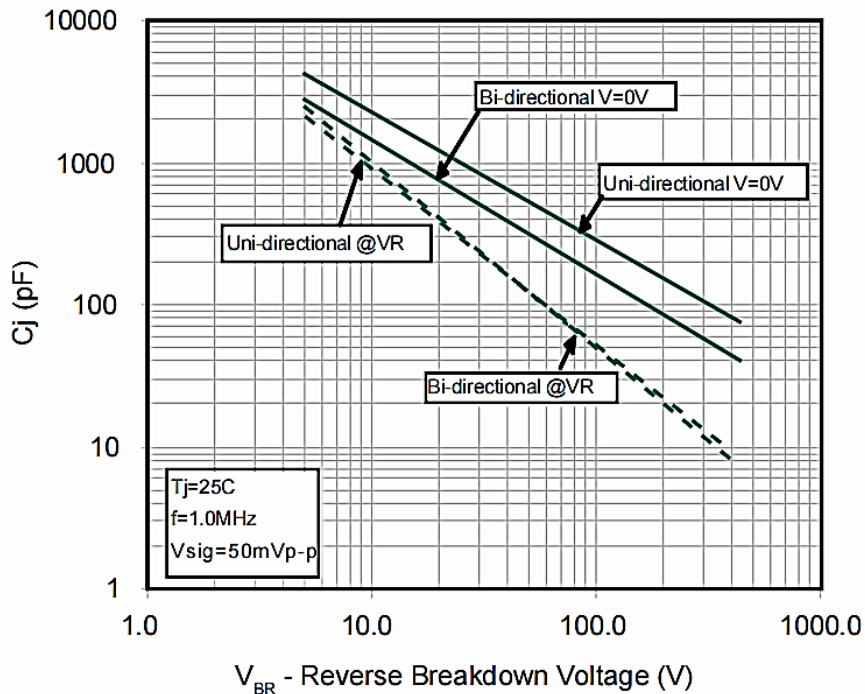

Figure 4. Typical Junction Capacitance



SMD TRANSIENT VOLTAGE SUPPRESSORS DIODES SMB SERIES

RATINGS AND CHARACTERISTIC CURVES (For Reference Only) - Ta= 25°C Unless Otherwise Specified

Figure 5. Steady State Power Dissipation Derating Curve

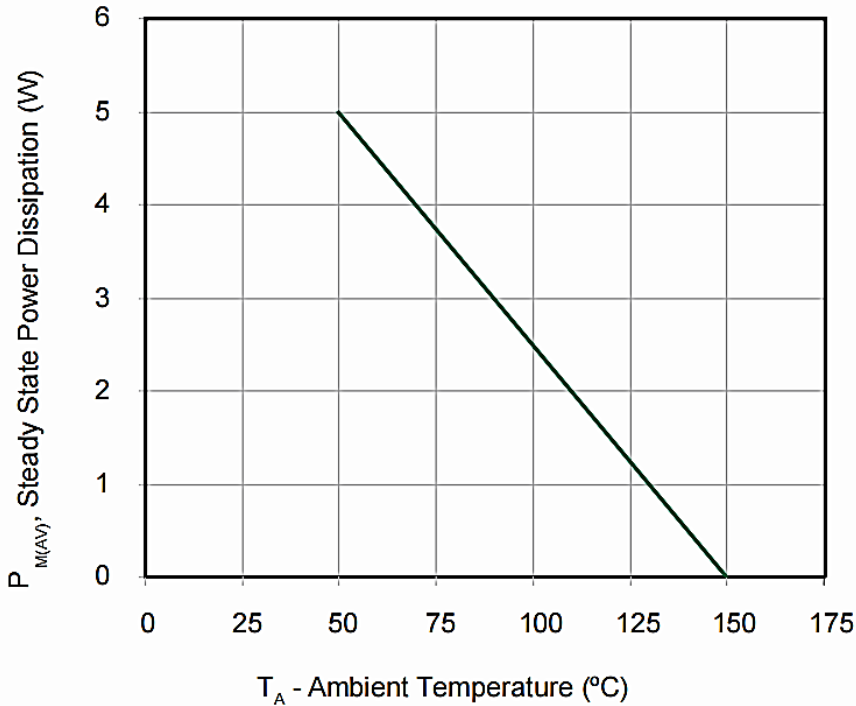
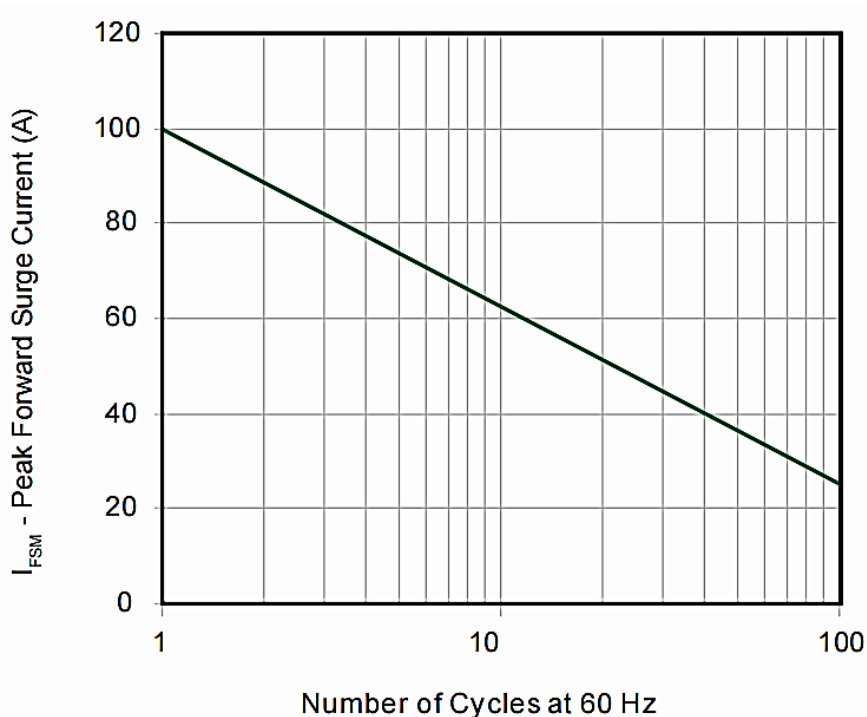

Figure 6. Maximum Non-Repetitive Peak Forward Surge Current Uni-Directional Only



SMD TRANSIENT VOLTAGE SUPPRESSORS DIODES SMB SERIES

TAPE/REEL (Unit: mm)

All Devices are packed in accordance with EIA standard RS-481-A and specifications.

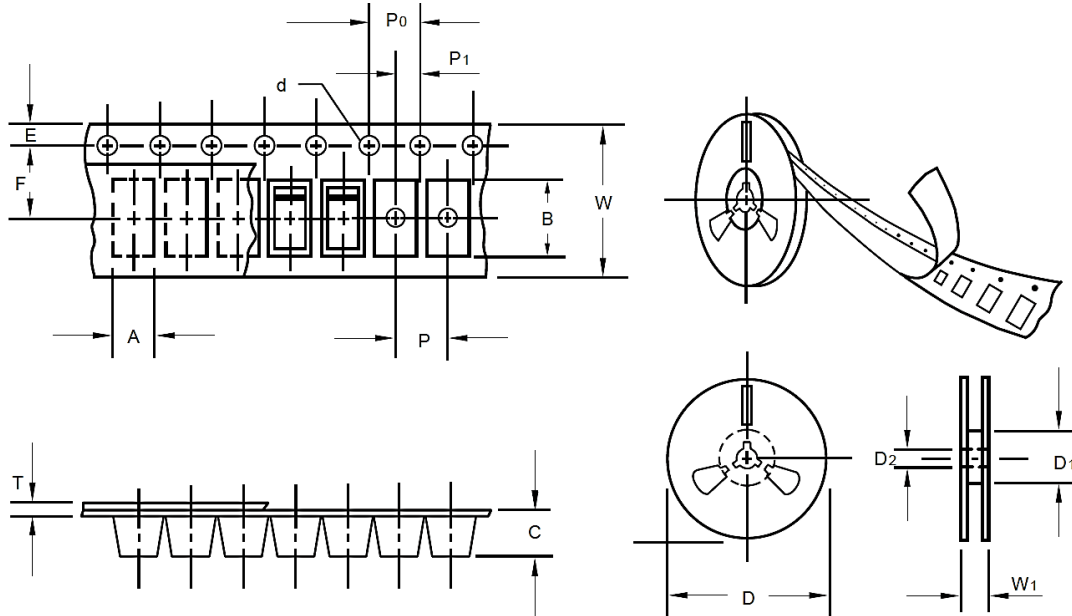

Item	Symbol	Tolerance	SMB/DO-214AA
Carrier width	A	0.1	3.81
Carrier Length	B	0.1	5.41
Carrier Depth	C	0.1	2.42
Sprocket hole	d	0.05	1.50
13"Reel outside diameter	D	2.0	330.00
13"Reel inner diameter	D1	Min.	50.00
7"Reel outside diameter	-	-	-
7"Reel inner diameter	-	-	-
Feed hole diameter	D2	0.5	13.00
Sprocket hole position	E	0.1	1.75
Punch hole position	F	0.1	5.55
Punch hole pitch	P	0.1	8.00
Sprocket hole pitch	P0	0.1	4.00
Embossment center	P1	0.1	2.00
Overall tape thickness	T	0.1	0.30
Tape width	W	0.3	12.00
Reel width	W1	1.0	12.30

SMD TRANSIENT VOLTAGE SUPPRESSORS DIODES SMB SERIES

PACKAGE For Reference Only

Case Code	SMB
Reel Size	13"
Reel Size	330 mm
SPQ/Reel	3000 pcs
Qty. /Box	6000 pcs
G.W/Box	/

GENERAL RETURN/REFUND POLICY

NextGen requires that customers first obtain an RMA (Returned Merchandise Authorization) number prior to returning any products. Returns must be made within 30 days of the date of invoice, be in the original packaging, unused and like-new condition. At the time of quoting or purchasing, a product may say that it is Non-Cancelable/Non-Returnable (NCNR). These products are not returnable and not refundable.

IMPORTANT NOTICE AND DISCLAIMER

- 1) NextGen Component, Inc. reserves the right to make changes to this document and its products and specifications at any time without notice. Customers should obtain and confirm the latest product information and specifications before final design, purchase or use.
- 2) NextGen Component, Inc makes no warranty, representation or guarantee regarding the suitability of its products for any particular purpose, not does NextGen Component, Inc assume any liability for application assistance or customer product design.
- 3) NextGen Component, Inc does not warrant or accept any liability with products which are purchased or used for any unintended or unauthorized application. No license is granted by implication or otherwise under any intellectual property rights of NextGen Component, Inc
- 4) NextGen Component, Inc. products are not authorized for use as critical components in life support devices or systems without express written approval of NextGen Component, Inc.