



**SPECIFICATION SHEET**

|   |   |  |
|---|---|--|
| <b>SPECIFICATION SHEET NO.</b>          | Q1103-BZT52C2V2SS0WZ  |  |
| <b>DATE</b>                             | Nov. 03, 2023   |  |
| <b>REVISION</b>                         | A0  | Updated With Most Recent Data - Official First Release |
| <b>DESCRIPTION AND MAIN PARAMETRICS</b> | <p>SMD Zener Diodes, BZT52C series, Case SOD-323</p> <p>BZT52C2V2S Type, 2 Pads</p> <p>Voltage - Zener (Nom.) (Vz): 2.2V, Peak Pulse Power: 200 mW</p> <p>Operating Temp. Range -55°C ~+150°C</p> <p>Package in Tape/Reel, 3000pcs/Reel</p> <p>RoHS III/REACH Compliant and Halogen Free (HF)</p> |  |
| <b>CUSTOMER</b>                         |   |  |
| <b>CUSTOMER PART NO.</b>                |   |  |
| <b>CROSS REF. PART NO.</b>              |   |  |
| <b>ORIGINAL MFG/PART NO.</b>            | MDD/BZT52C2V2S  |  |
| <b>PART CODE</b>                        | BZT52C2V2SS0WZ  |  |

|  |
|--|
| <b>VENDOR APPROVE</b>  |
| Issued/Checked/Approved    |
| DATE: Nov. 03, 2023  |

|                         |
|-------------------------|
| <b>CUSTOMER APPROVE</b> |
|                         |
| DATE:                   |

**SMD ZENER DIODES BZT52C SERIES CASE SOD-323**

**MAIN FEATURE**

- Small Signal Zener Diodes
- SOD-323 Plastic-Encapsulate Diodes
- Total power dissipation: Max. 300mW.
- Planar die construction
- General purpose and medium current
- Wide Zener reverse voltage range 2.0V to 75V.
- Small plastic package suitable for surface mounted design.
- Tolerance approximately  $\pm 5\%$
- REACH/RoHS III Complaint and Halogen Free
- Cross Main Competitor Parts in Market



**APPLICATION**

- For SMD application

**RFQ**

[Request For Quotation](#)

**PART CODE GUIDE**

| BZT52C | 2V2S | S | 0WZ |
|--------|------|---|-----|
| 1      | 2    | 3 | 4   |

1. BZT52C: SMD Zener Diodes, BZT52C series Code
2. 2V2S: Specification code for Voltage - Zener (Nom) (Vz): 2.2V, Package Case SOD-323
3. S: Package code, Tape/Reel
4. 0WZ: Marking code for "WZ" on the case surface, Different Marking for different specification

**ELECTRICAL CHARACTERISTICS**

See Page 5 ~ Page 6 For Different Part Code

**HOW TO ORDER**

Please indicate part code and send us your RFQ by E-mail, [sales@nextgencomponent.com](mailto:sales@nextgencomponent.com)

**SMD ZENER DIODES BZT52C SERIES CASE SOD-323**

**DIMENSION** - Unit: Inch/mm

Image for reference



**Marking:** Standard

\* See Marking Code List at  
Page 5~ Page 6



**Case Dimension:**  
SOD-323

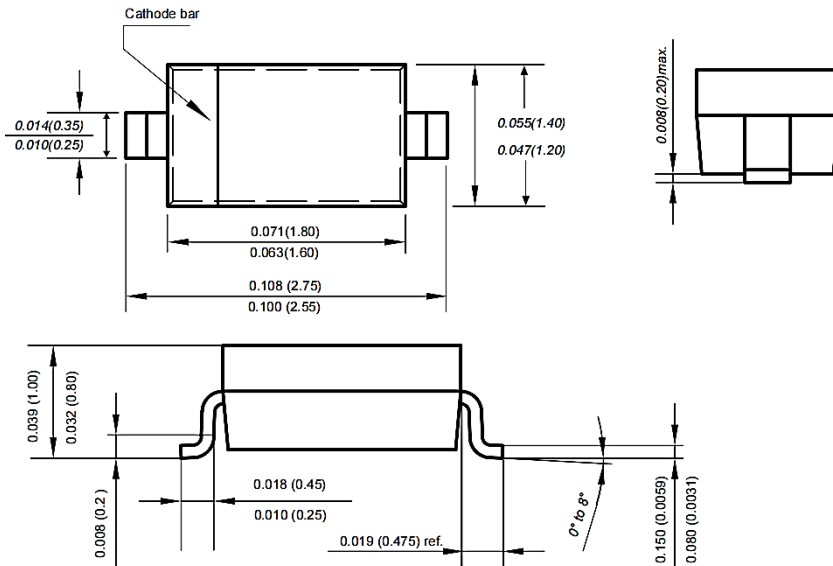

**Recommend  
Pad Layout**

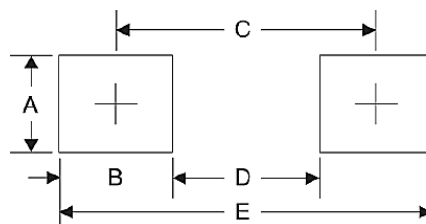

| Symbol | Unit<br>(Inch) | Unit<br>(mm) |
|--------|----------------|--------------|
| A      | 0.028          | 0.70         |
| B      | 0.028          | 0.70         |
| C      | 0.085          | 2.15         |
| D      | 0.071          | 1.80         |
| E      | 0.112          | 2.85         |

**SMD ZENER DIODES BZT52C SERIES CASE SOD-323**
**MECHANICAL DATA**

| Case                                    | Terminals                                     | Polarity                           | Mounting Position | Marking                                     | Weight per piece               |
|---|---|------------------------------------|-------------------|---|--------------------------------|
| JEDEC SOD-323<br>molded plastic<br>body | Solderable per<br>MIL-STD-750,<br>Method 2026 | Polarity symbol<br>marking on body | ANY               | See Marking<br>Code List<br>(Page 5~Page 6) | 0.00019 ounce<br>0.00548 grams |

**MAX. RATING & CHARACTERISTICS** - Ratings at 25°C Ambient Temperature Unless Otherwise Specified.

| Parameter   | SYMBOLS          | VALUE      | UNITS |
|---|------------------|------------|-------|
| Forward Voltage @ I <sub>F</sub> =10mA (Note 2)                 | V <sub>F</sub>   | 0.9        | V     |
| Peak Pulse Power Dissipation at TA=50°C (Note 1)                | P <sub>D</sub>   | 200        | mW    |
| Typical Thermal Resistance From Junction To Ambient<br>(Note 1) | R <sub>θJA</sub> | 417        | °C/W  |
| Operating Junction Temperature Range                            | T <sub>J</sub>   | -55 ~ +150 | °C    |
| Storage Temperature Range                                       | T <sub>stg</sub> | -55 ~ +150 | °C    |

**Notes**

1. Thermal Resistance From Junction To Ambient at P.C.B. Mounted With 2.0" X 2.0" (5 X 5 cm) Copper Areas Pads.
2. Short Duration Test Pulse Used To Minimize Self-heating Effect.
3. f=1kHz

**SMD ZENER DIODES BZT52C SERIES CASE SOD-323**
**ELECTRICAL CHARACTERISTICS UNIDIRECTIONAL TYPE - Ta = 25°C**

| Part Code             | Zener Voltage Range<br>(See Note 1)<br>V <sub>ZT</sub> @ I <sub>ZT</sub><br>(V) |            |             | Test Current<br>I <sub>ZT</sub><br>(mA) | Dynamic Impedance<br>Max. Z <sub>ZT</sub><br>@ I <sub>ZT</sub><br>(Ω) | Reverse Current          |                      | Marking Code |
|-----------------------|---|------------|-------------|---|---|--------------------------|----------------------|--------------|
|                       | Min.  | Nom        | Max.        |   |   | Max. I <sub>R</sub> (μA) | @ V <sub>R</sub> (V) |              |
| BZT52C2V0SS0WY        | 1.8   | 2          | 2.15        | 5                                       | 100   | 120                      | 0.5                  | WY           |
| <b>BZT52C2V2SS0WZ</b> | <b>2.08</b>   | <b>2.2</b> | <b>2.33</b> | <b>5</b>                                | <b>100</b>  | <b>120</b>               | <b>0.7</b>           | <b>WZ</b>    |
| BZT52C2V4SS0WX        | 2.28  | 2.4        | 2.56        | 5                                       | 100   | 120                      | 1                    | WX           |
| BZT52C2V7SS0W1        | 2.5   | 2.7        | 2.9         | 5                                       | 110   | 120                      | 1                    | W1           |
| BZT52C3V0SS0W2        | 2.8   | 3          | 3.2         | 5                                       | 120   | 50                       | 1                    | W2           |
| BZT52C3V3SS0W3        | 3.1   | 3.3        | 3.5         | 5                                       | 130   | 20                       | 1                    | W3           |
| BZT52C3V6SS0W4        | 3.4   | 3.6        | 3.8         | 5                                       | 130   | 10                       | 1                    | W4           |
| BZT52C3V9SS0W5        | 3.7   | 3.9        | 4.1         | 5                                       | 130   | 5                        | 1                    | W5           |
| BZT52C4V3SS0W6        | 4   | 4.3        | 4.6         | 5                                       | 130   | 5                        | 1                    | W6           |
| BZT52C4V7SS0W7        | 4.4   | 4.7        | 5           | 5                                       | 130   | 2                        | 1                    | W7           |
| BZT52C5V1SS0W8        | 4.8   | 5.1        | 5.4         | 5                                       | 130   | 2                        | 1.5                  | W8           |
| BZT52C5V6SS0W9        | 5.2   | 5.6        | 6           | 5                                       | 80  | 1                        | 2.5                  | W9           |
| BZT52C6V2SS0WA        | 5.8   | 6.2        | 6.6         | 5                                       | 50  | 1                        | 3                    | WA           |
| BZT52C6V8SS0WB        | 6.4   | 6.8        | 7.2         | 5                                       | 30  | 0.5                      | 3.5                  | WB           |
| BZT52C7V5SS0WC        | 7   | 7.5        | 7.9         | 5                                       | 30  | 0.5                      | 4                    | WC           |
| BZT52C8V2SS0WD        | 7.7   | 8.2        | 8.7         | 5                                       | 30  | 0.5                      | 5                    | WD           |
| BZT52C9V1SS0WE        | 8.5   | 9.1        | 9.6         | 5                                       | 30  | 0.5                      | 6                    | WE           |
| BZT52C10SS00WF        | 9.4   | 10         | 10.6        | 5                                       | 30  | 0.1                      | 7                    | WF           |
| BZT52C11SS00WG        | 10.4  | 11         | 11.6        | 5                                       | 30  | 0.1                      | 8                    | WG           |
| BZT52C12SS00WH        | 11.4  | 12         | 12.7        | 5                                       | 35  | 0.1                      | 9                    | WH           |
| BZT52C13SS00WI        | 12.4  | 13         | 14.1        | 5                                       | 35  | 0.1                      | 10                   | WI           |

**SMD ZENER DIODES BZT52C SERIES CASE SOD-323**
**ELECTRICAL CHARACTERISTICS UNIDIRECTIONAL TYPE - Ta = 25°C**

| Part Code      | Zener Voltage Range<br>(See Note 1)<br>V <sub>ZT</sub> @ I <sub>ZT</sub><br>(V) |     |      | Test Current<br>I <sub>ZT</sub><br>(mA) | Dynamic Impedance<br>Max. Z <sub>T</sub><br>@ I <sub>ZT</sub><br>(Ω) | Reverse Current          |                      | Marking Code |
|----------------|---|-----|------|---|--|--------------------------|----------------------|--------------|
|                | Min.  | Nom | Max. |   |  | Max. I <sub>R</sub> (μA) | @ V <sub>R</sub> (V) |              |
| BZT52C15SS00WJ | 13.8  | 15  | 15.6 | 5                                       | 40   | 0.1                      | 11                   | WJ           |
| BZT52C16SS00WK | 15.3  | 16  | 17.1 | 5                                       | 40   | 0.1                      | 12                   | WK           |
| BZT52C18SS00WL | 16.8  | 18  | 19.1 | 5                                       | 45   | 0.1                      | 13                   | WL           |
| BZT52C20SS00WM | 18.8  | 20  | 21.2 | 5                                       | 50   | 0.1                      | 15                   | WM           |
| BZT52C22SS00WN | 20.8  | 22  | 23.3 | 5                                       | 55   | 0.1                      | 17                   | WN           |
| BZT52C24SS00WO | 22.8  | 24  | 25.6 | 5                                       | 60   | 0.1                      | 19                   | WO           |
| BZT52C27SS00WP | 25.1  | 27  | 28.9 | 2                                       | 70   | 0.1                      | 21                   | WP           |
| BZT52C30SS00WQ | 28  | 30  | 32   | 2                                       | 80   | 0.1                      | 23                   | WQ           |
| BZT52C33SS00WR | 31  | 33  | 35   | 2                                       | 80   | 0.1                      | 25                   | WR           |
| BZT52C36SS00WS | 34  | 36  | 38   | 2                                       | 90   | 0.1                      | 27                   | WS           |
| BZT52C39SS00WT | 37  | 39  | 41   | 2                                       | 100  | 0.1                      | 30                   | WT           |
| BZT52C43SS00WU | 40  | 43  | 46   | 2                                       | 130  | 0.1                      | 33                   | WU           |
| BZT52C47SS00WV | 44  | 47  | 50   | 2                                       | 150  | 0.1                      | 36                   | WV           |
| BZT52C51SS00WW | 48  | 51  | 54   | 2                                       | 180  | 0.1                      | 39                   | WW           |
| BZT52C56SS00XW | 52  | 56  | 60   | 2                                       | 200  | 0.1                      | 43                   | XW           |
| BZT52C62SS006E | 58  | 62  | 66   | 2                                       | 215  | 0.1                      | 47                   | 6E           |
| BZT52C68SS006F | 64  | 68  | 72   | 2                                       | 240  | 0.1                      | 52                   | 6F           |
| BZT52C75SS006H | 70  | 75  | 79   | 2                                       | 265  | 0.1                      | 56                   | 6H           |

Notes 1: V<sub>ZT</sub> is tested with pulses (20 ms)

**SMD ZENER DIODES BZT52C SERIES CASE SOD-323**

**RATINGS AND CHARACTERISTIC CURVES** (For Reference Only) -  $T_a = 25^\circ\text{C}$  Unless Otherwise Specified

Figure 1. Forward Characteristics Curve

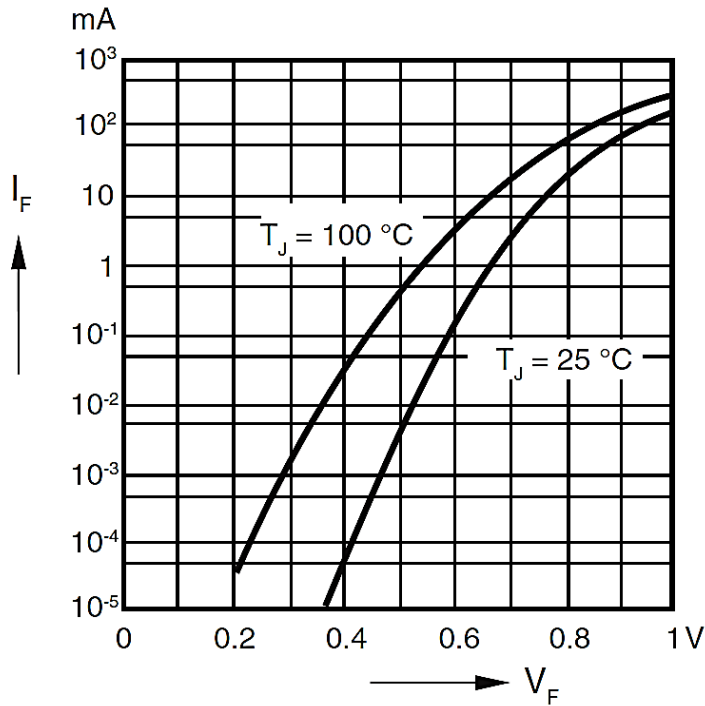
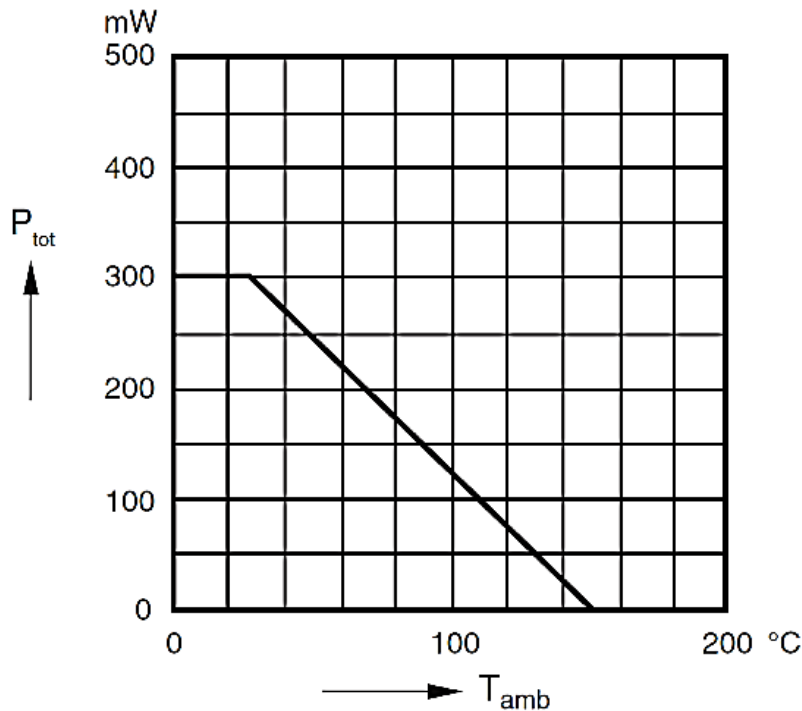

Figure 2. Admissible Power Dissipation vs. Ambient Temperature Curve



**SMD ZENER DIODES BZT52C SERIES CASE SOD-323**

**RATINGS AND CHARACTERISTIC CURVES** (For Reference Only) -  $T_a = 25^\circ\text{C}$  Unless Otherwise Specified

Figure 3. Dynamic Resistance vs. Zener Current Curve

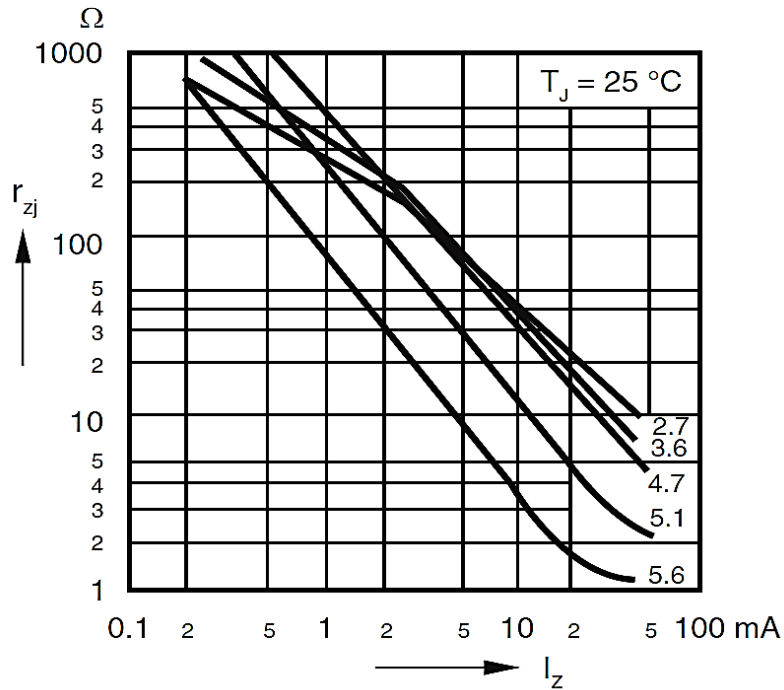
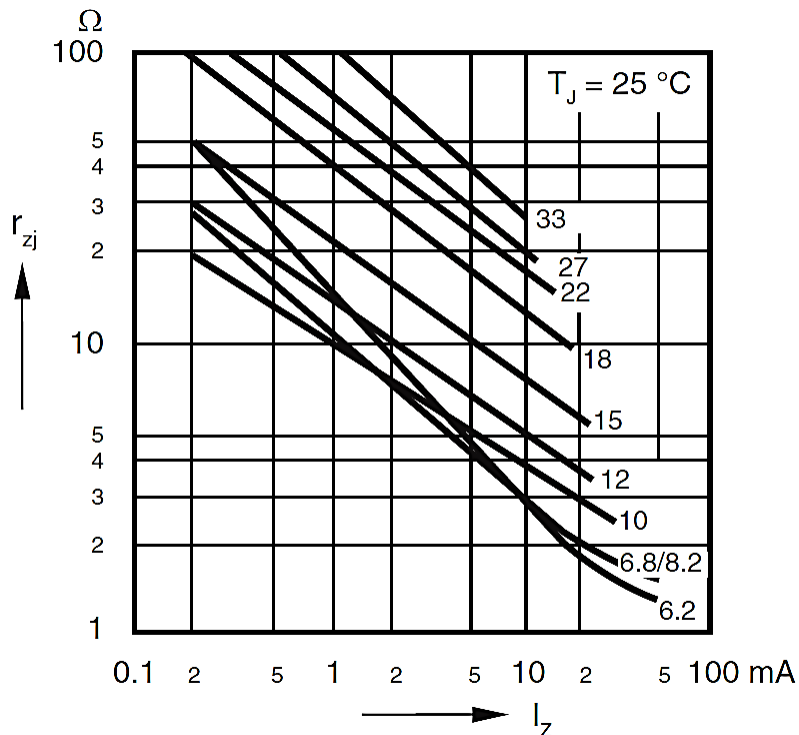

Figure 4. Dynamic Resistance vs. Zener Current Curve





**SMD ZENER DIODES BZT52C SERIES CASE SOD-323**

**RATINGS AND CHARACTERISTIC CURVES** (For Reference Only) - Ta= 25°C Unless Otherwise Specified

Figure 5. Dynamic Resistance vs. Zener Current Curve

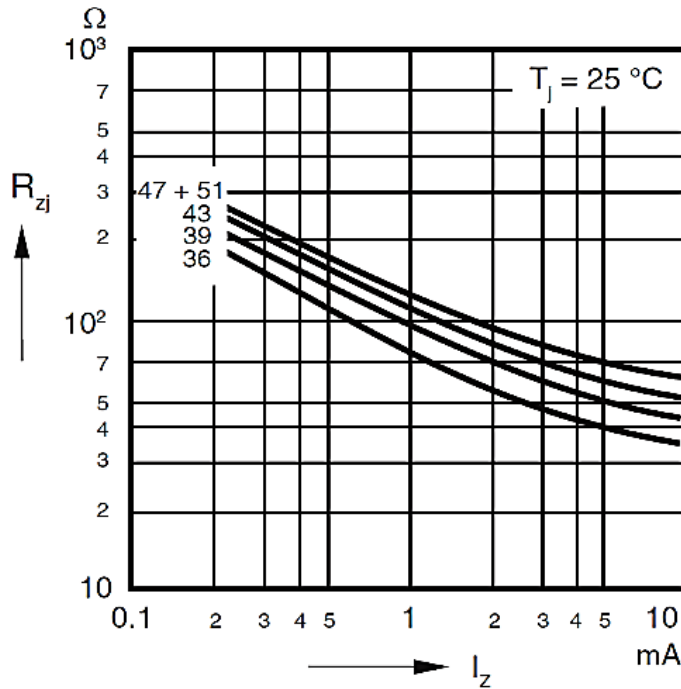
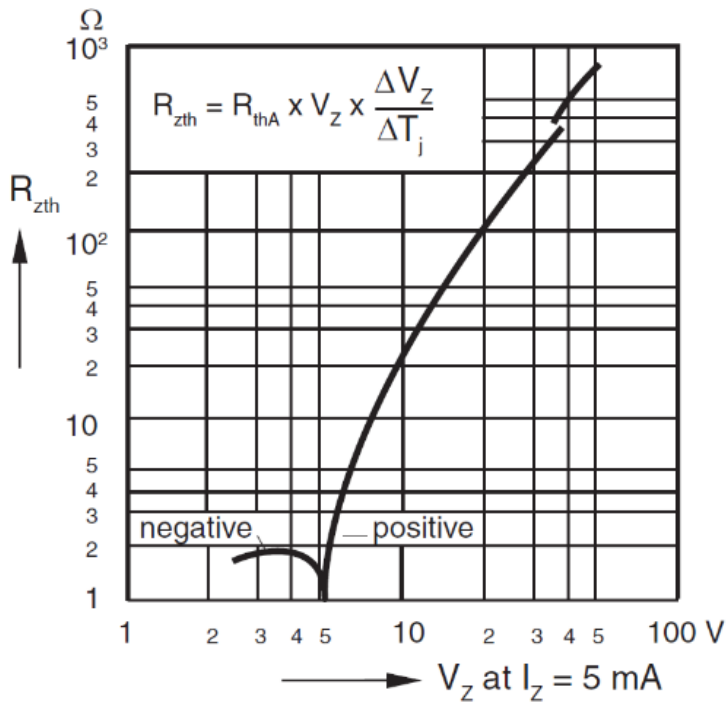

Figure 6. Thermal Differential Resistance vs. Zener Voltage Curve



**SMD ZENER DIODES BZT52C SERIES CASE SOD-323**

**RATINGS AND CHARACTERISTIC CURVES** (For Reference Only) -  $T_a = 25^\circ\text{C}$  Unless Otherwise Specified

Figure 7. Dynamic Resistance vs. Zener Voltage Curve

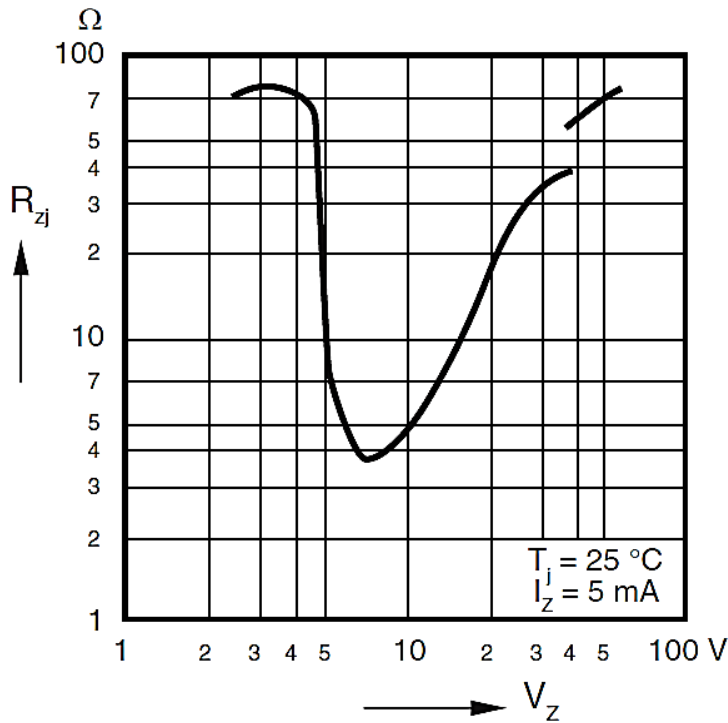
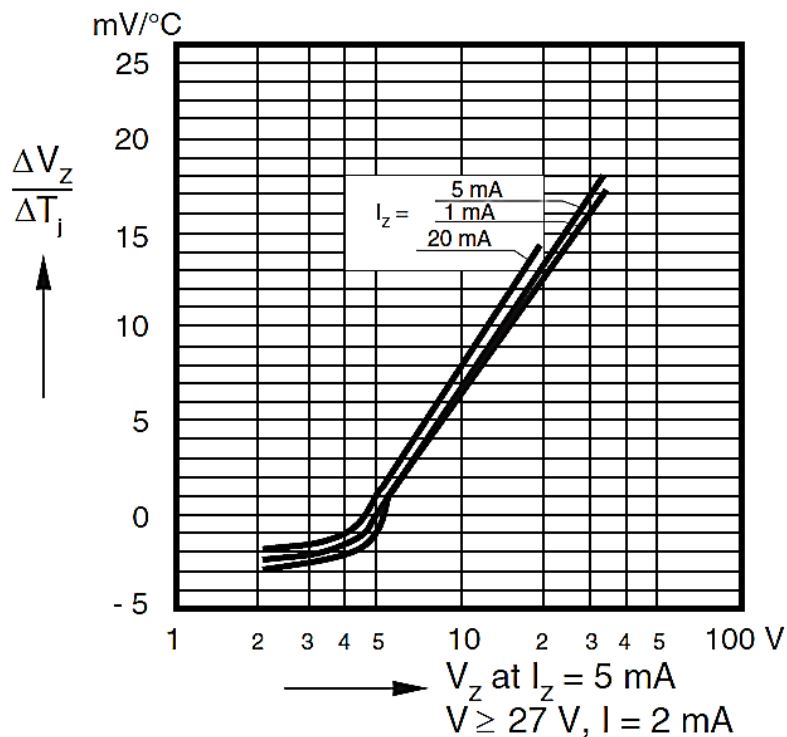

Figure 8. Temperature Dependence vs. Zener Voltage Curve



**SMD ZENER DIODES BZT52C SERIES CASE SOD-323**

**RATINGS AND CHARACTERISTIC CURVES** (For Reference Only) - Ta= 25°C Unless Otherwise Specified

Figure 9. Change of Zener Voltage vs. Junction Temp. Curve

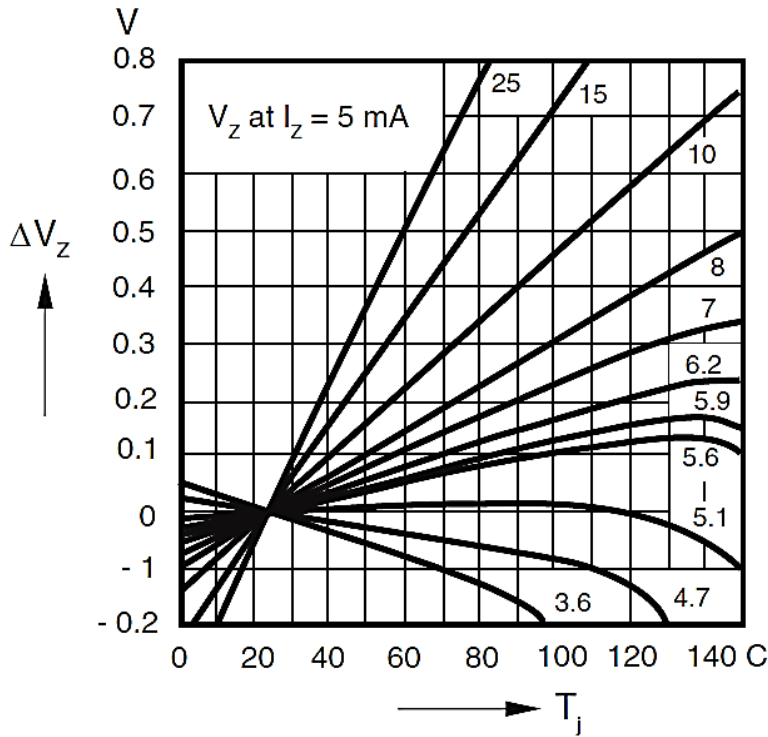
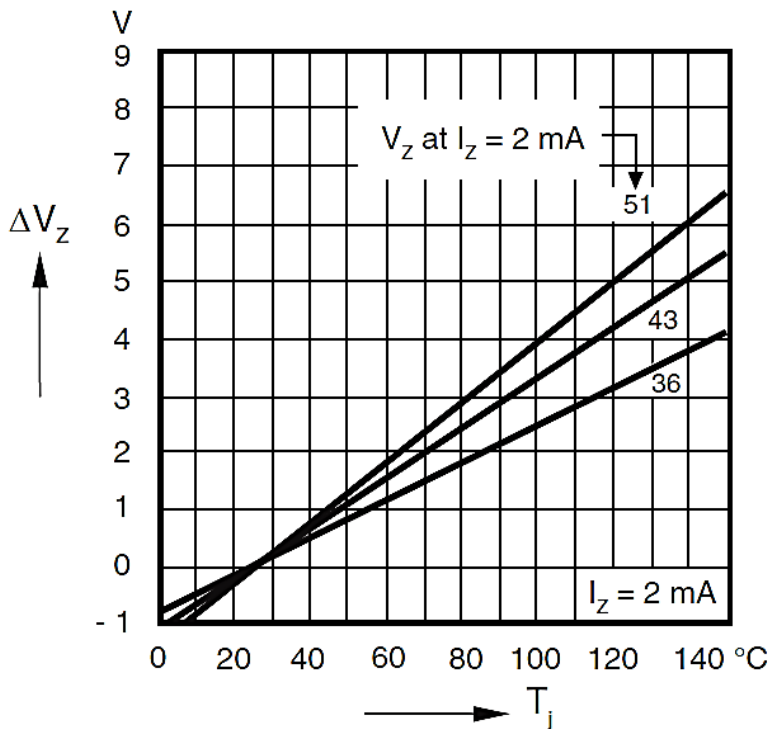

Figure 10. Change of Zener Voltage vs. Junction Temperature Curve



**SMD ZENER DIODES BZT52C SERIES CASE SOD-323**

**RATINGS AND CHARACTERISTIC CURVES** (For Reference Only) - Ta= 25°C Unless Otherwise Specified

Figure 11. Temperature Dependence vs. Zener Voltage. Curve

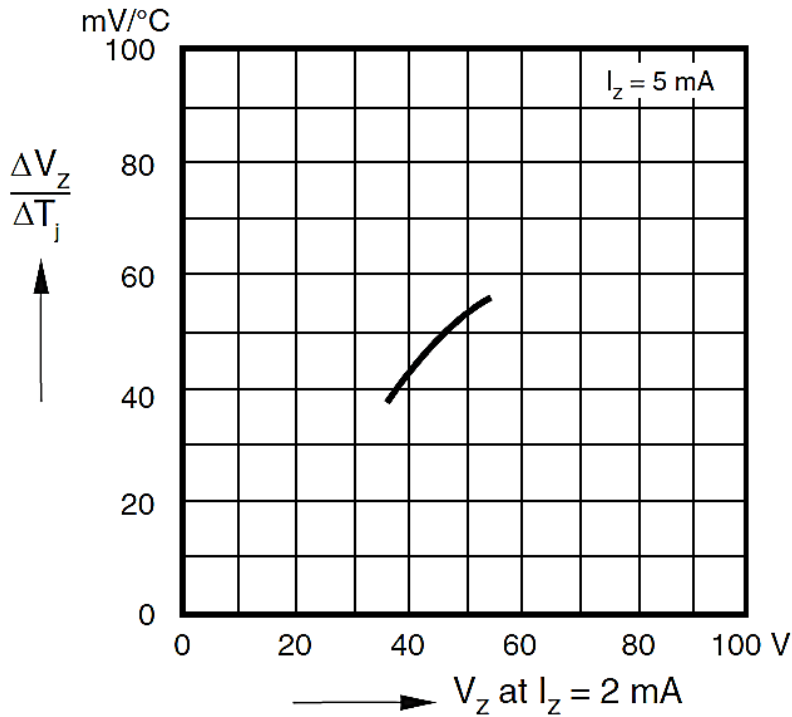
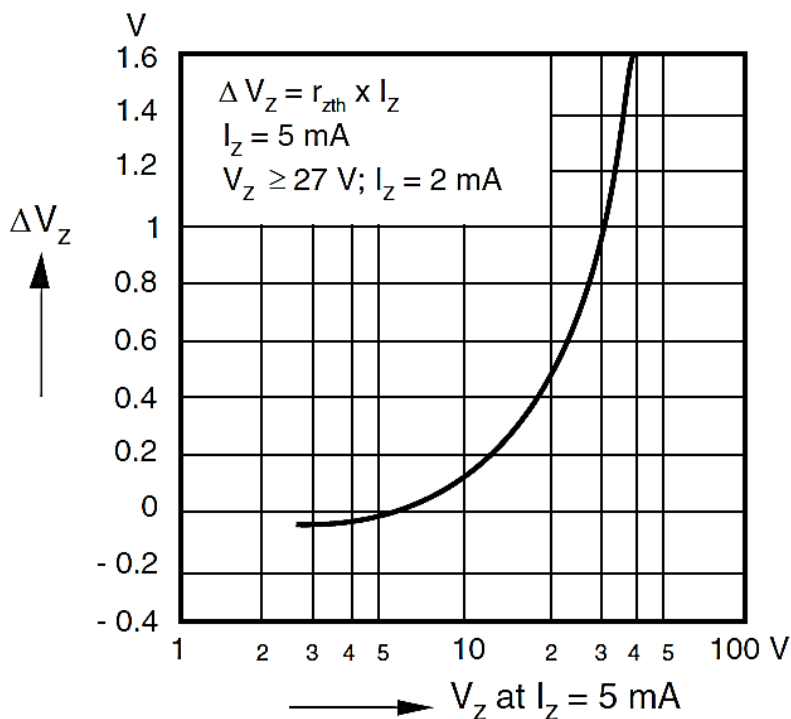

Figure 12. Change of Zener Voltage from Turn-on up to the Point of Thermal Equilibrium vs. Zener Voltage Curve



**SMD ZENER DIODES BZT52C SERIES CASE SOD-323**

**RATINGS AND CHARACTERISTIC CURVES** (For Reference Only) - Ta= 25°C Unless Otherwise Specified

Figure 13. Change of Zener Voltage from Turn-on up to the Point of Thermal Equilibrium vs. Zener Voltage. Curve

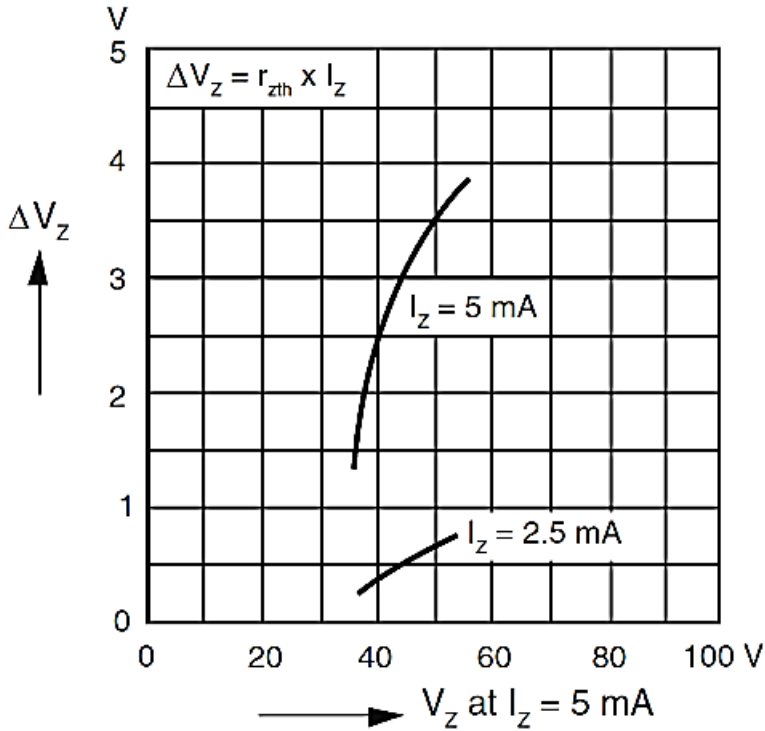
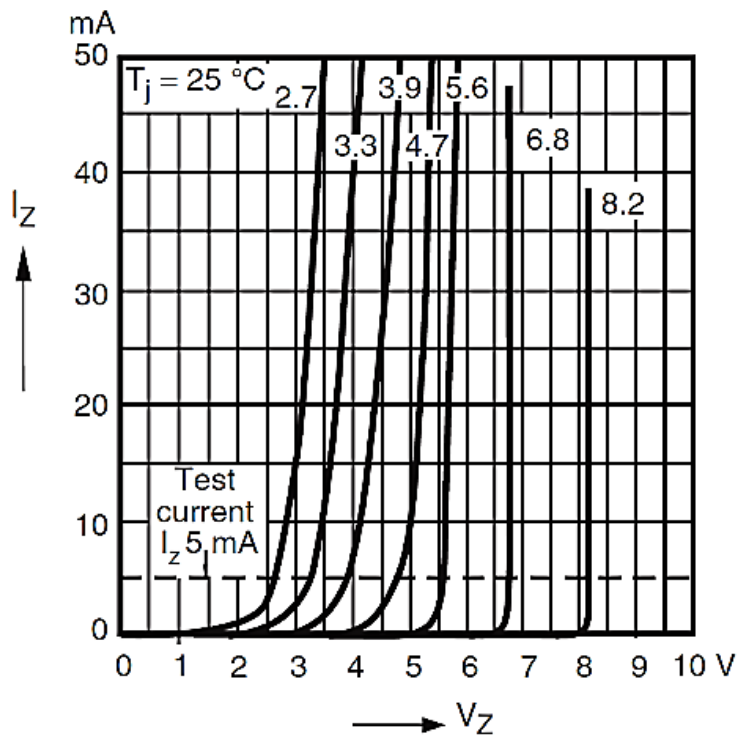

Figure 14. Breakdown Characteristics Curve



**SMD ZENER DIODES BZT52C SERIES CASE SOD-323**

**RATINGS AND CHARACTERISTIC CURVES** (For Reference Only) -  $T_a = 25^\circ\text{C}$  Unless Otherwise Specified

Figure 15. Breakdown Characteristics Curve

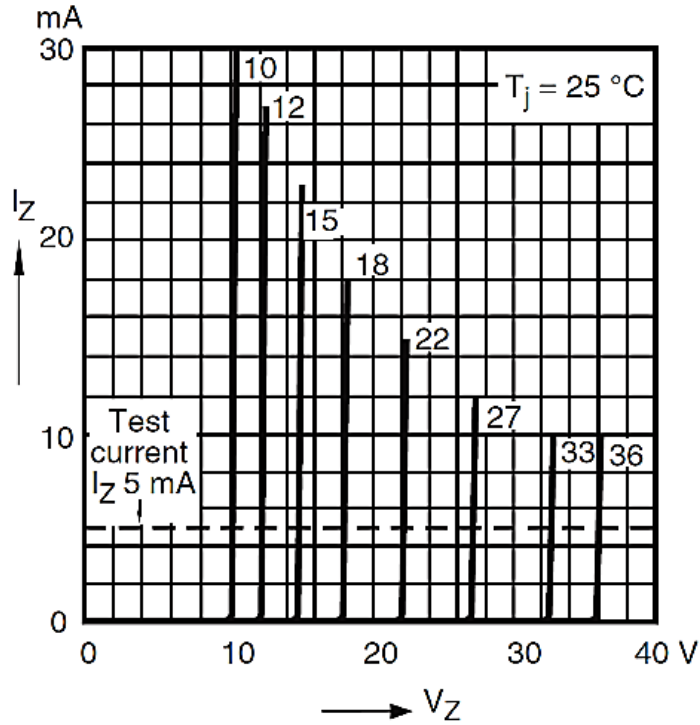
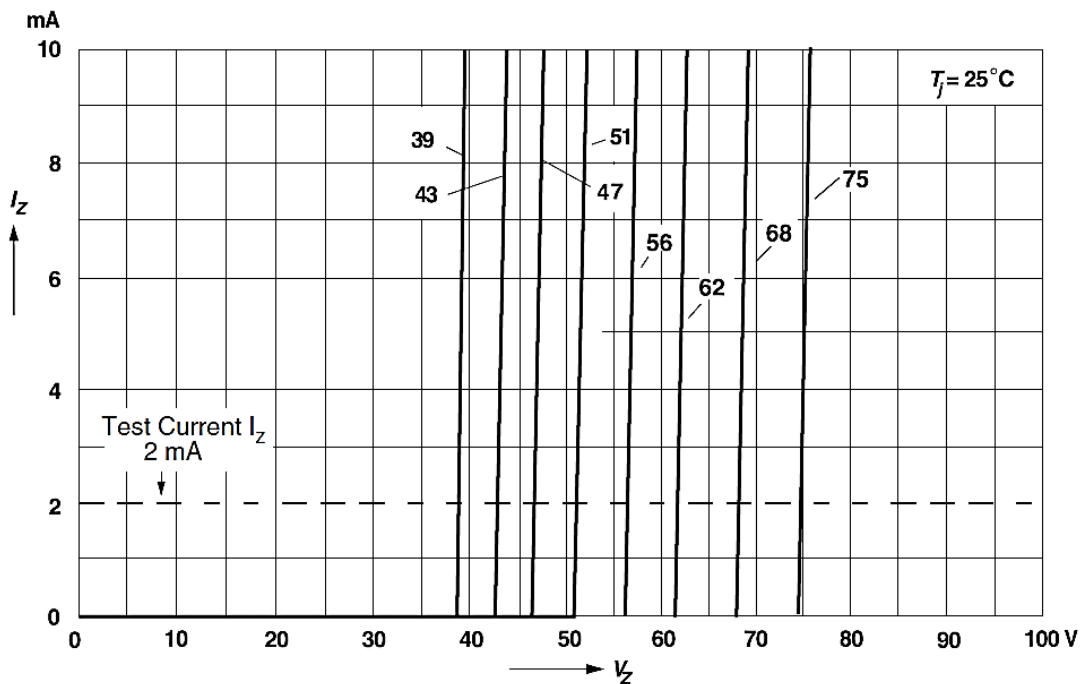

Figure 16. Breakdown Characteristics Curve



**SMD ZENER DIODES BZT52C SERIES CASE SOD-323**
**RELIABILITY**

| Number | Experiment Items                   | Experiment Method And Conditions   | Reference Documents             |
|--------|------------------------------------|--|---------------------------------|
| 1      | Solder Resistance Test             | Test 260°C± 5°C for 10 ± 2 sec.<br>Immerse body into solder 1/16" ± 1/32"                                      | MIL-STD-750D<br>METHOD-2031.2   |
| 2      | Solderability Test                 | 230°C ±5°C for 5 sec.  | MIL-STD-750D<br>METHOD-2026.1 0 |
| 3      | Pull Test                          | 1 kg in axial lead direction for 10 sec.   | MIL-STD-750D<br>METHOD-2036.4   |
| 4      | Bend Test                          | 0.5Kg Weight Applied To Each Lead,<br>Bending Arcs 90 °C ± 5 °C For 3 Times                                    | MIL-STD-750D<br>METHOD-2036.4   |
| 5      | High Temperature Reverse Bias Test | TA=100°C for 1000 Hours at VR=80%<br>Rated VR  | MIL-STD-750D<br>METHOD-1038.4   |
| 6      | Forward Operation Life Test        | TA=25°C Rated Average Rectified<br>Current   | MIL-STD-750D<br>METHOD-1027.3   |
| 7      | Intermittent Operation Life Test   | On state: 5 min with rated IRMS Power<br>Off state: 5 min with Cool Forced Air.<br>On and off for 1000 cycles. | MIL-STD-750D<br>METHOD-1036.3   |
| 8      | Pressure Cooker Test               | 15 PSIG, TA=121°C, 4 hours   | MIL-S-19500<br>APPENOIXC        |
| 9      | Temperature Cycling Test           | -55°C~+125°C; 30 Minutes For Dwelled<br>Time 5 minutes for transferred time.<br>Total: 10 cycles.              | MIL-STD-750D<br>METHOD-1051.7   |
| 10     | Thermal Shock Test                 | 0°C for 5 minutes., 100°C for 5minutes,<br>Total: 10 cycles  | MIL-STD-750D<br>METHOD-1056.7   |
| 11     | Forward Surge Test                 | 8.3ms Single Sale Sine-wave One Surge.   | MIL-STD-750D<br>METHOD-4066.4   |
| 12     | Humidity Test                      | TA=65°C, RH=98% for 1000 hours.  | MIL-STD-750D<br>METHOD-1021.3   |
| 13     | High Temperature Storage life Test | 150°C for 1000 Hours   | MIL-STD-750D<br>METHOD-1031.5   |

**SMD ZENER DIODES BZT52C SERIES CASE SOD-323**

**SUGGESTED REFLOW PROFILE - For Reference Only**



| Profile Feature                                 |                           | Pb-Free Assembly  |
|---|---------------------------|-------------------|
| Average Ramp-up Rate (Ts Max to Tp)             |                           | 3°C/second Max    |
| Preheat   | Temperature Min (Ts Min.) | 150°C             |
|   | Temperature Max (Ts Max.) | 200°C             |
|   | Time (ts Min. to ts Max.) | 60 ~ 180 seconds  |
| Time maintained above                           | Temperature (Tl)          | 217°C             |
|   | Time (tl)                 | 60 ~ 150 seconds  |
| Peak/Classification Temperature (Tp)            |                           | 260 °C            |
| Time within 5°C of actual Peak Temperature (tp) |                           | 20 ~ 40 seconds   |
| Ramp-down rate                                  |                           | 6 °C /Second Max. |
| Time 25 °C to Peak Temperature                  |                           | 8 minutes Max.    |
| Suggest reflow times                            |                           | 3 Times Max.      |



**SMD ZENER DIODES BZT52C SERIES CASE SOD-323**

**TAPE/REEL, 3000pcs/Reel** (Unit: mm)

All Devices are packed in accordance with EIA standard RS-481-A and Tape wide 8mm, Component Spacing 4.0mm

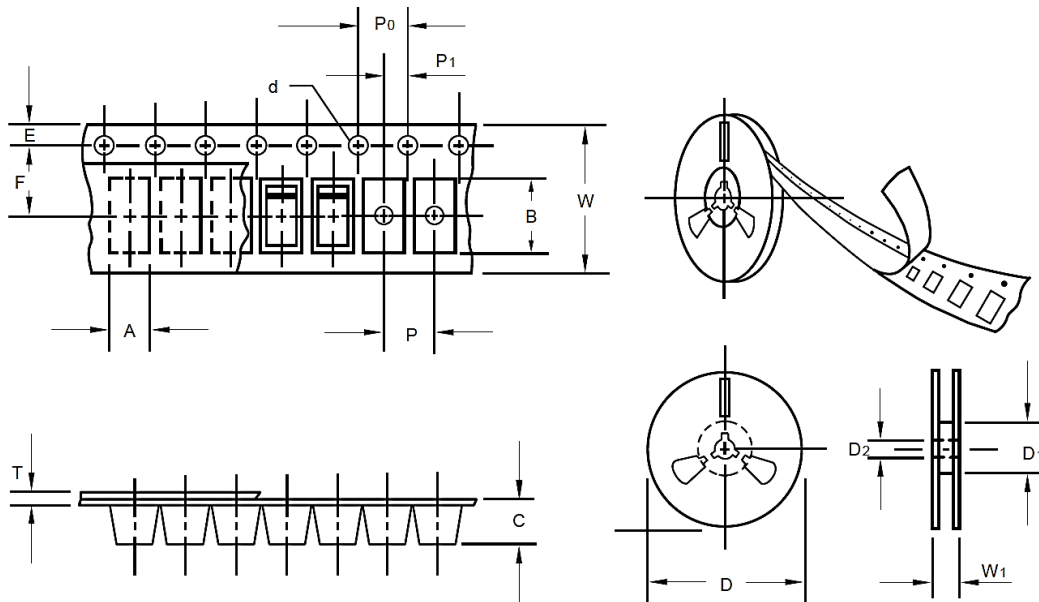

| Item                     | Symbol | Tolerance | Case SOD-323 |
|--------------------------|--------|-----------|--------------|
| Carrier width            | A      | 0.1       | 2.10         |
| Carrier Length           | B      | 0.1       | 4.00         |
| Carrier Depth            | C      | 0.1       | 1.60         |
| Sprocket hole            | d      | 0.05      | 1.55         |
| 13"Reel outside diameter | -      | -         | -            |
| 13"Reel inner diameter   | -      | -         | -            |
| 7"Reel outside diameter  | D      | 2.0       | 178.00       |
| 7"Reel inner diameter    | D1     | Min.      | 50.00        |
| Feed hole diameter       | D2     | 0.5       | 13.00        |
| Sprocket hole position   | E      | 0.1       | 1.75         |
| Punch hole position      | F      | 0.1       | 3.50         |
| Punch hole pitch         | P      | 0.1       | 4.00         |
| Sprocket hole pitch      | P0     | 0.1       | 4.00         |
| Embossment center        | P1     | 0.1       | 2.00         |
| Overall tape thickness   | T      | 0.1       | 0.25         |
| Tape width               | W      | 0.3       | 8.15         |
| Reel width               | W1     | 1.0       | 10.50        |

## SMD ZENER DIODES BZT52C SERIES CASE SOD-323

### ROHS COMPLIANCE

- The levels of RoHS restricted materials in this product are below the maximum concentration values (also referred to as the threshold limits) permitted for such substances, or are used in an exempted application, in accordance with EU RoHS Directive (EU) 2015/863 EC (RoHS3). RoHS Test Report for this product can be obtained can be obtained at Download Center.

### REACH COMPLIANCE

- REACH substances of high concern (SVHCs) information is available for this product. Since the European Chemical Agency (ECHA) has published notice of their intent to frequently revise the SVHC listing for the foreseeable future, REACH Test Report for this product can be obtained can be obtained at Download Center.

### IMPORTANT NOTES AND DISCLAIMER

- 1) All Product parametric performance is indicated in the Electrical Characteristics for the listed herein test conditions, unless otherwise noted. Product performance may not be indicated by the Electrical Characteristics if operated under different conditions.
- 2) NextGen Component, Inc (*NextGen*) reserves the right to make changes to this document and its products and specifications at any time without notice. Customers should obtain and confirm the latest product information and specifications before final design, purchase or use.
- 3) *NextGen* makes no warranty, representation or guarantee regarding the suitability of its products for any particular purpose, nor does NextGen assume any liability for application assistance or customer product design.
- 4) *NextGen* does not warrant or accept any liability with products which are purchased or used for any unintended or unauthorized application. No license is granted by implication or otherwise under any intellectual property rights of NextGen.
- 5) *NextGen* products are not authorized for use as critical components in life support devices or systems without express written approval by *NextGen*.
- 6) *NextGen* requires that customers first obtain an RMA (Returned Merchandise Authorization) number prior to returning any products. Returns must be made within 30 days of the date of invoice, be in the original packaging, unused and like-new condition. At the time of quoting or purchasing, a product may say that it is Non-Cancelable/ Non-Returnable (NCNR). These products are not returnable and not refundable.