



**SPECIFICATION SHEET**

<b>SPECIFICATION SHEET NO.</b>	Q1103-BZT52C75SS006H	
<b>DATE</b>	Nov. 03, 2023	
<b>REVISION</b>	A0	Updated With Most Recent Data - Official First Release
<b>DESCRIPTION AND MAIN PARAMETRICS</b>	<p>SMD Zener Diodes, BZT52C series, Case SOD-323</p> <p>BZT52C75S Type, 2 Pads</p> <p>Voltage - Zener (Nom.) (Vz): 75V, Peak Pulse Power: 200 mW</p> <p>Operating Temp. Range -55°C ~+150°C</p> <p>Package in Tape/Reel, 3000pcs/Reel</p> <p>RoHS III/REACH Compliant and Halogen Free (HF)</p>	
<b>CUSTOMER</b>		
<b>CUSTOMER PART NO.</b>		
<b>CROSS REF. PART NO.</b>		
<b>ORIGINAL MFG/PART NO.</b>	MDD/BZT52C75S	
<b>PART CODE</b>	BZT52C75SS006H	

<b>VENDOR APPROVE</b>
<p>Issued/Checked/Approved</p> <div style="display: flex; justify-content: space-around; align-items: center;">    </div>
DATE: Nov. 03, 2023

<b>CUSTOMER APPROVE</b>
DATE:

**SMD ZENER DIODES BZT52C SERIES CASE SOD-323**

**MAIN FEATURE**

- Small Signal Zener Diodes
- SOD-323 Plastic-Encapsulate Diodes
- Total power dissipation: Max. 300mW.
- Planar die construction
- General purpose and medium current
- Wide Zener reverse voltage range 2.0V to 75V.
- Small plastic package suitable for surface mounted design.
- Tolerance approximately  $\pm 5\%$
- REACH/RoHS III Complaint and Halogen Free
- Cross Main Competitor Parts in Market



**APPLICATION**

- For SMD application

**RFQ**

[Request For Quotation](#)

**PART CODE GUIDE**

BZT52C	75S	S	006H
1	2	3	4

1. BZT52C: SMD Zener Diodes, BZT52C series Code
2. 75S: Specification code for Voltage - Zener (Nom) (Vz): 75V, Package Case SOD-323
3. S: Package code, Tape/Reel
4. 006H: Marking code for "6H" on the case surface, Different Marking for different specification

**ELECTRICAL CHARACTERISTICS**

See Page 5 ~ Page 6 For Different Part Code

**HOW TO ORDER**

Please indicate part code and send us your RFQ by E-mail, [sales@nextgencomponent.com](mailto:sales@nextgencomponent.com)

**SMD ZENER DIODES BZT52C SERIES CASE SOD-323**

**DIMENSION** - Unit: Inch/mm

Image for reference



**Marking:** Standard

\* See Marking Code List at  
Page 5~ Page 6



**Case Dimension:**  
SOD-323

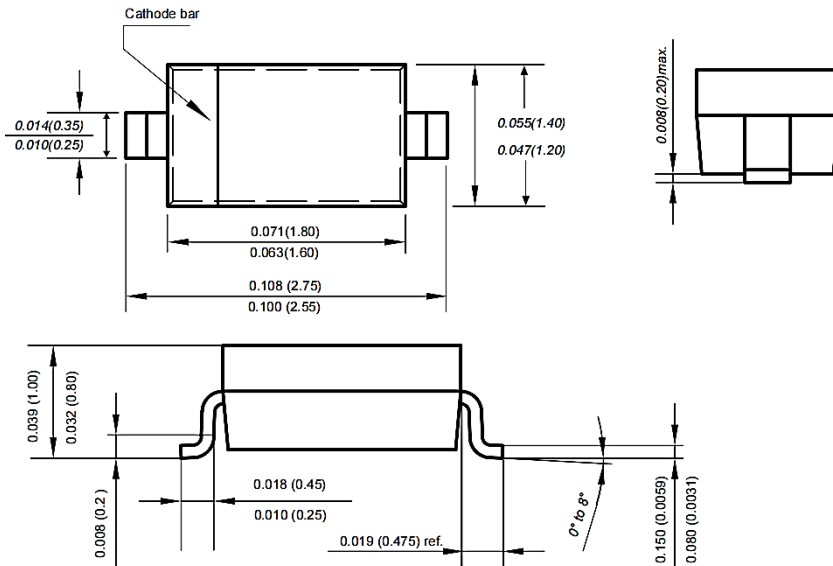

**Recommend  
Pad Layout**

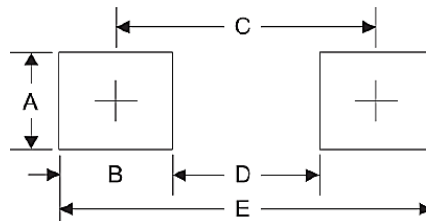

Symbol	Unit (Inch)	Unit (mm)
A	0.028	0.70
B	0.028	0.70
C	0.085	2.15
D	0.071	1.80
E	0.112	2.85

**SMD ZENER DIODES BZT52C SERIES CASE SOD-323**
**MECHANICAL DATA**

Case	Terminals	Polarity	Mounting Position	Marking	Weight per piece
JEDEC SOD-323 molded plastic body	Solderable per MIL-STD-750, Method 2026	Polarity symbol marking on body	ANY	See Marking Code List (Page 5~Page 6)	0.00019 ounce 0.00548 grams

**MAX. RATING & CHARACTERISTICS** - Ratings at 25°C Ambient Temperature Unless Otherwise Specified.

Parameter	SYMBOLS	VALUE	UNITS
Forward Voltage @ I <sub>F</sub> =10mA (Note 2)	V <sub>F</sub>	0.9	V
Peak Pulse Power Dissipation at TA=50°C (Note 1)	P <sub>D</sub>	200	mW
Typical Thermal Resistance From Junction To Ambient (Note 1)	R <sub>θJA</sub>	417	°C/W
Operating Junction Temperature Range	T <sub>J</sub>	-55 ~ +150	°C
Storage Temperature Range	T <sub>stg</sub>	-55 ~ +150	°C

**Notes**

1. Thermal Resistance From Junction To Ambient at P.C.B. Mounted With 2.0" X 2.0" (5 X 5 cm) Copper Areas Pads.
2. Short Duration Test Pulse Used To Minimize Self-heating Effect.
3. f=1kHz

**SMD ZENER DIODES BZT52C SERIES CASE SOD-323**
**ELECTRICAL CHARACTERISTICS UNIDIRECTIONAL TYPE - Ta = 25°C**

Part Code	Zener Voltage Range (See Note 1) V <sub>ZT</sub> @ I <sub>ZT</sub> (V)			Test Current I <sub>ZT</sub> (mA)	Dynamic Impedance Max. Z <sub>ZT</sub> @ I <sub>ZT</sub> (Ω)	Reverse Current		Marking Code
	Min.	Nom	Max.			Max. I <sub>R</sub> (μA)	@ V <sub>R</sub> (V)	
BZT52C2V0SS0WY	1.8	2	2.15	5	100	120	0.5	WY
BZT52C2V2SS0WZ	2.08	2.2	2.33	5	100	120	0.7	WZ
BZT52C2V4SS0WX	2.28	2.4	2.56	5	100	120	1	WX
BZT52C2V7SS0W1	2.5	2.7	2.9	5	110	120	1	W1
BZT52C3V0SS0W2	2.8	3	3.2	5	120	50	1	W2
BZT52C3V3SS0W3	3.1	3.3	3.5	5	130	20	1	W3
BZT52C3V6SS0W4	3.4	3.6	3.8	5	130	10	1	W4
BZT52C3V9SS0W5	3.7	3.9	4.1	5	130	5	1	W5
BZT52C4V3SS0W6	4	4.3	4.6	5	130	5	1	W6
BZT52C4V7SS0W7	4.4	4.7	5	5	130	2	1	W7
BZT52C5V1SS0W8	4.8	5.1	5.4	5	130	2	1.5	W8
BZT52C5V6SS0W9	5.2	5.6	6	5	80	1	2.5	W9
BZT52C6V2SS0WA	5.8	6.2	6.6	5	50	1	3	WA
BZT52C6V8SS0WB	6.4	6.8	7.2	5	30	0.5	3.5	WB
BZT52C7V5SS0WC	7	7.5	7.9	5	30	0.5	4	WC
BZT52C8V2SS0WD	7.7	8.2	8.7	5	30	0.5	5	WD
BZT52C9V1SS0WE	8.5	9.1	9.6	5	30	0.5	6	WE
BZT52C10SS00WF	9.4	10	10.6	5	30	0.1	7	WF
BZT52C11SS00WG	10.4	11	11.6	5	30	0.1	8	WG
BZT52C12SS00WH	11.4	12	12.7	5	35	0.1	9	WH
BZT52C13SS00WI	12.4	13	14.1	5	35	0.1	10	WI

**SMD ZENER DIODES BZT52C SERIES CASE SOD-323**
**ELECTRICAL CHARACTERISTICS UNIDIRECTIONAL TYPE - Ta = 25°C**

Part Code	Zener Voltage Range (See Note 1) V <sub>ZT</sub> @ I <sub>ZT</sub> (V)			Test Current I <sub>ZT</sub> (mA)	Dynamic Impedance Max. Z <sub>T</sub> @ I <sub>ZT</sub> (Ω)	Reverse Current		Marking Code
	Min.	Nom	Max.			Max. I <sub>R</sub> (μA)	@ V <sub>R</sub> (V)	
BZT52C15SS00WJ	13.8	15	15.6	5	40	0.1	11	WJ
BZT52C16SS00WK	15.3	16	17.1	5	40	0.1	12	WK
BZT52C18SS00WL	16.8	18	19.1	5	45	0.1	13	WL
BZT52C20SS00WM	18.8	20	21.2	5	50	0.1	15	WM
BZT52C22SS00WN	20.8	22	23.3	5	55	0.1	17	WN
BZT52C24SS00WO	22.8	24	25.6	5	60	0.1	19	WO
BZT52C27SS00WP	25.1	27	28.9	2	70	0.1	21	WP
BZT52C30SS00WQ	28	30	32	2	80	0.1	23	WQ
BZT52C33SS00WR	31	33	35	2	80	0.1	25	WR
BZT52C36SS00WS	34	36	38	2	90	0.1	27	WS
BZT52C39SS00WT	37	39	41	2	100	0.1	30	WT
BZT52C43SS00WU	40	43	46	2	130	0.1	33	WU
BZT52C47SS00WV	44	47	50	2	150	0.1	36	WV
BZT52C51SS00WW	48	51	54	2	180	0.1	39	WW
BZT52C56SS00XW	52	56	60	2	200	0.1	43	XW
BZT52C62SS006E	58	62	66	2	215	0.1	47	6E
BZT52C68SS006F	64	68	72	2	240	0.1	52	6F
<b>BZT52C75SS006H</b>	<b>70</b>	<b>75</b>	<b>79</b>	<b>2</b>	<b>265</b>	<b>0.1</b>	<b>56</b>	<b>6H</b>

Notes 1: V<sub>ZT</sub> is tested with pulses (20 ms)

**SMD ZENER DIODES BZT52C SERIES CASE SOD-323**

**RATINGS AND CHARACTERISTIC CURVES** (For Reference Only) -  $T_a = 25^\circ\text{C}$  Unless Otherwise Specified

Figure 1. Forward Characteristics Curve

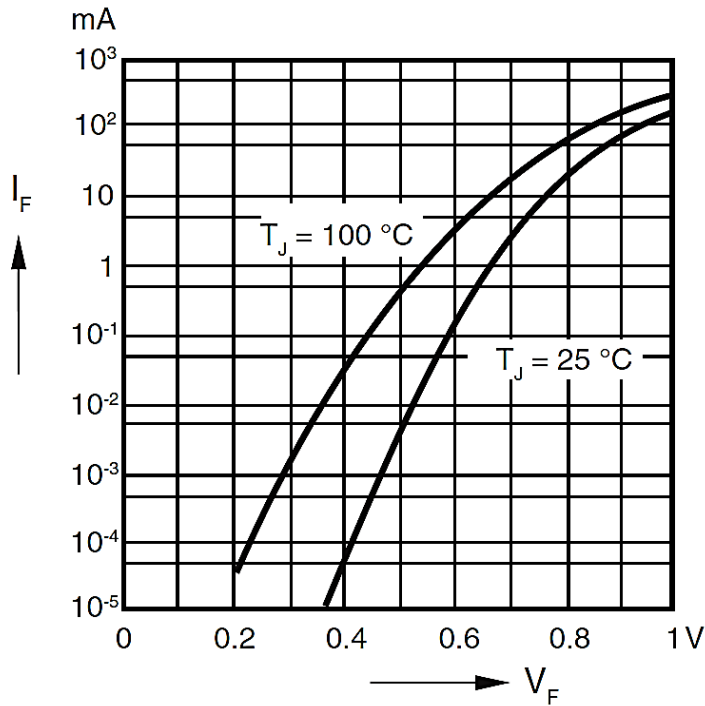
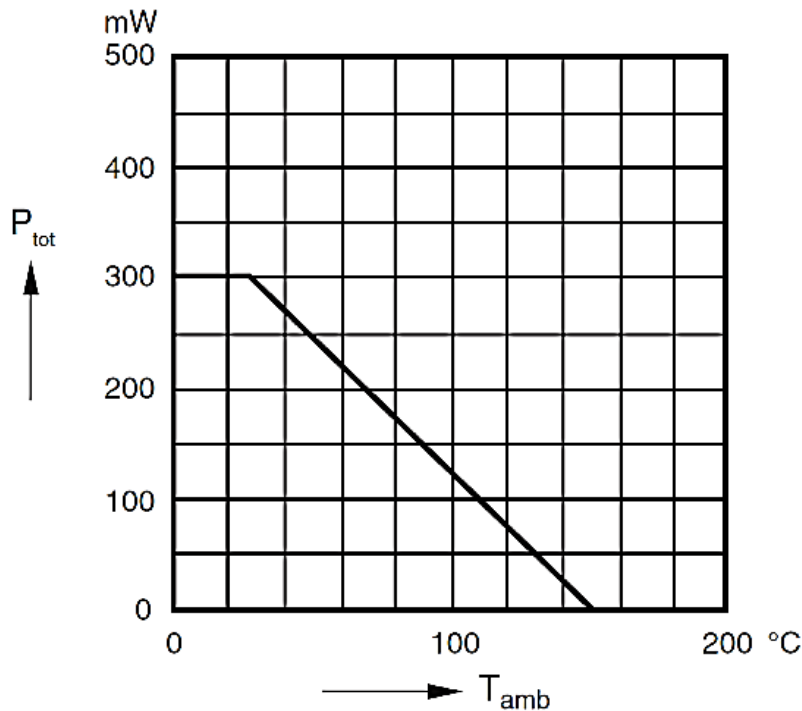

Figure 2. Admissible Power Dissipation vs. Ambient Temperature Curve



**SMD ZENER DIODES BZT52C SERIES CASE SOD-323**

**RATINGS AND CHARACTERISTIC CURVES** (For Reference Only) -  $T_a = 25^\circ\text{C}$  Unless Otherwise Specified

Figure 3. Dynamic Resistance vs. Zener Current Curve

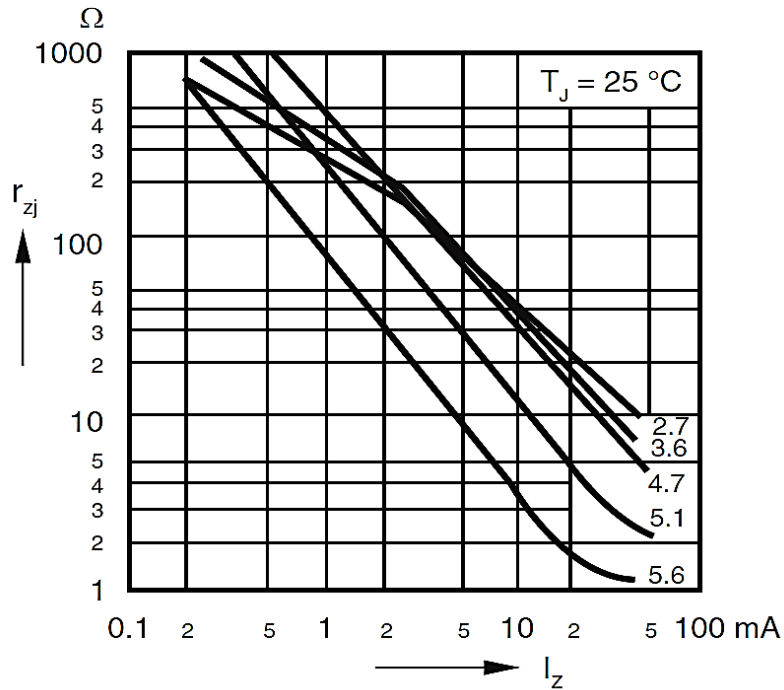
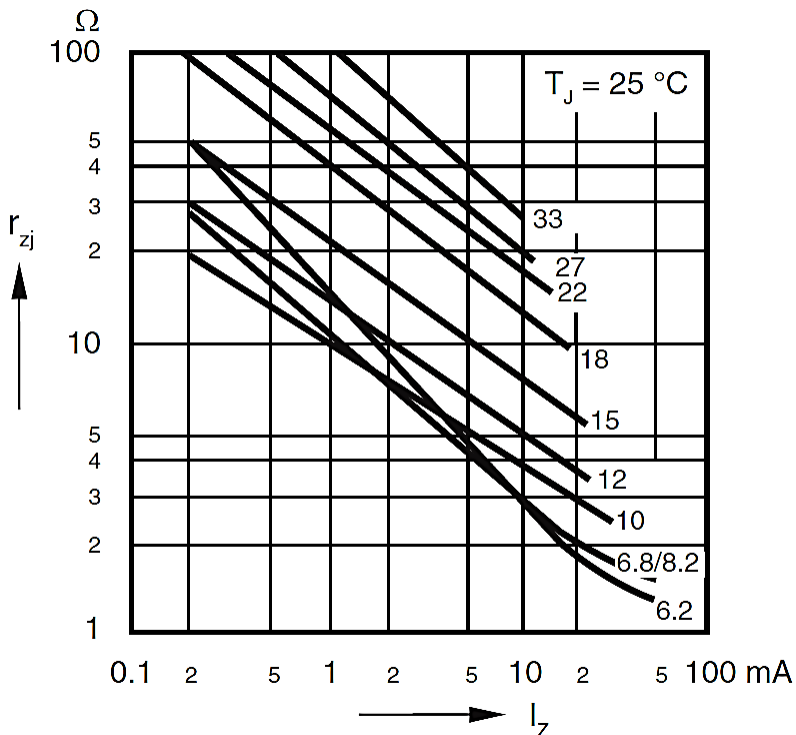

Figure 4. Dynamic Resistance vs. Zener Current Curve





**SMD ZENER DIODES BZT52C SERIES CASE SOD-323**

**RATINGS AND CHARACTERISTIC CURVES** (For Reference Only) - Ta= 25°C Unless Otherwise Specified

Figure 5. Dynamic Resistance vs. Zener Current Curve

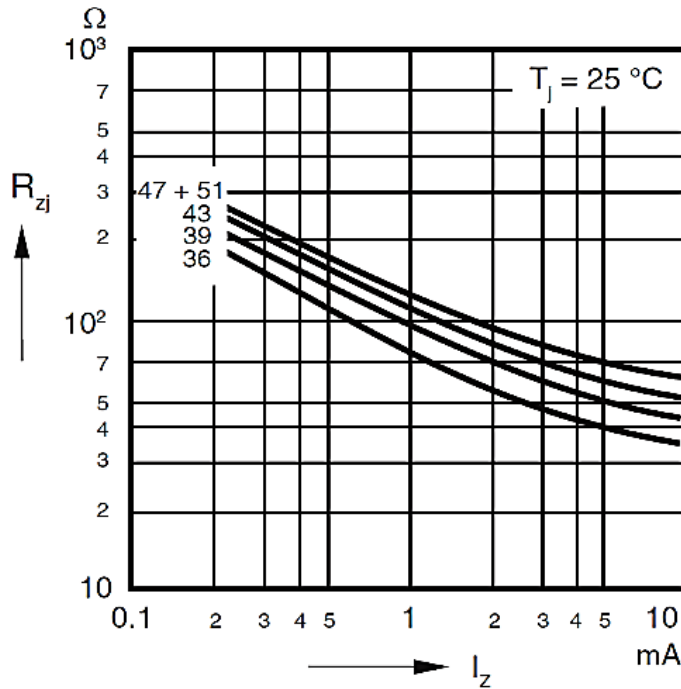
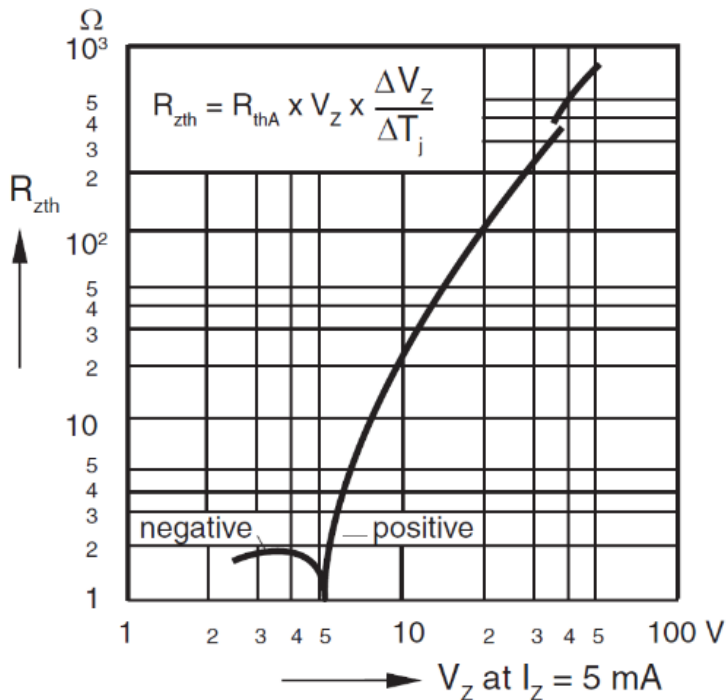

Figure 6. Thermal Differential Resistance vs. Zener Voltage Curve



**SMD ZENER DIODES BZT52C SERIES CASE SOD-323**

**RATINGS AND CHARACTERISTIC CURVES** (For Reference Only) -  $T_a = 25^\circ\text{C}$  Unless Otherwise Specified

Figure 7. Dynamic Resistance vs. Zener Voltage Curve

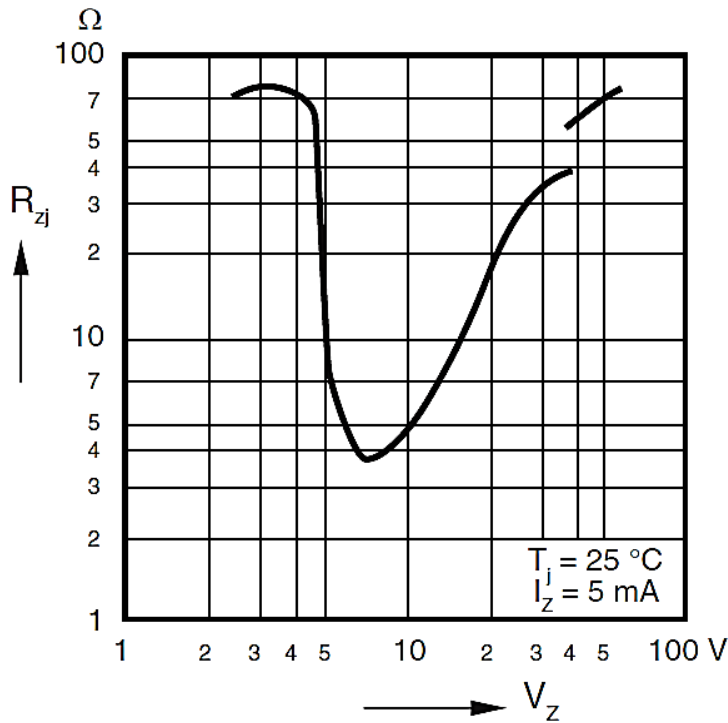
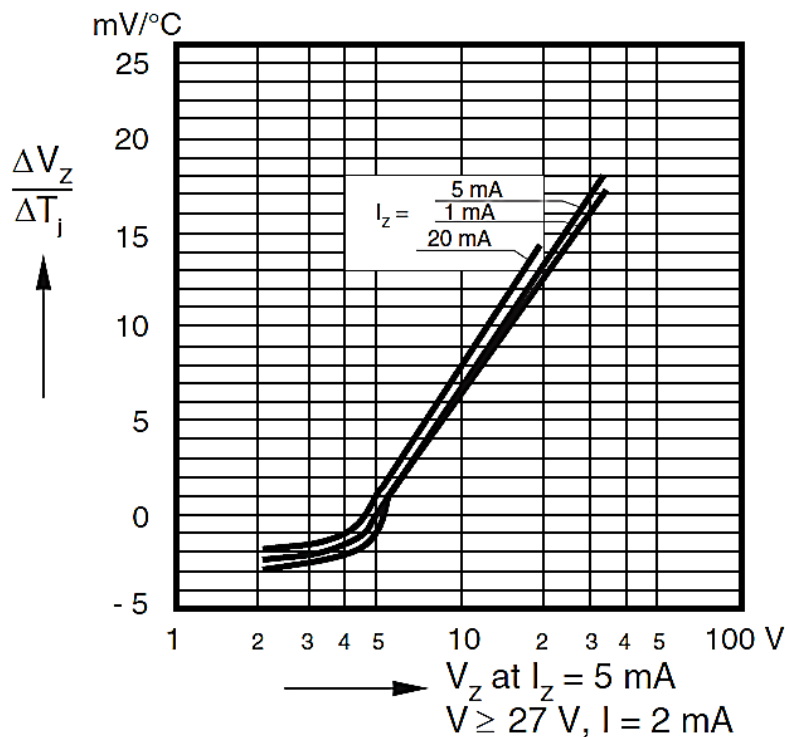

Figure 8. Temperature Dependence vs. Zener Voltage Curve



**SMD ZENER DIODES BZT52C SERIES CASE SOD-323**

**RATINGS AND CHARACTERISTIC CURVES** (For Reference Only) -  $T_a = 25^\circ\text{C}$  Unless Otherwise Specified

Figure 9. Change of Zener Voltage vs. Junction Temp. Curve

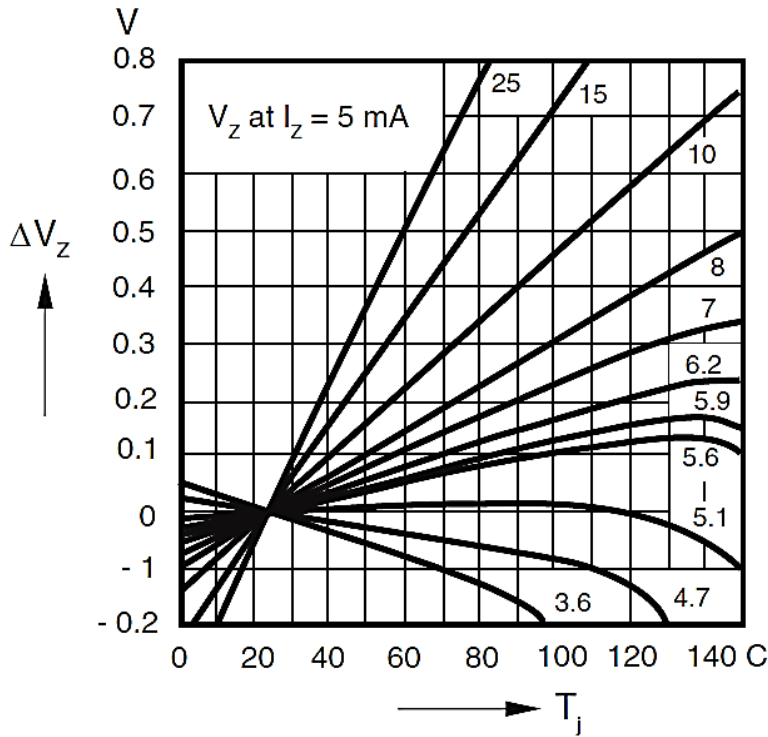
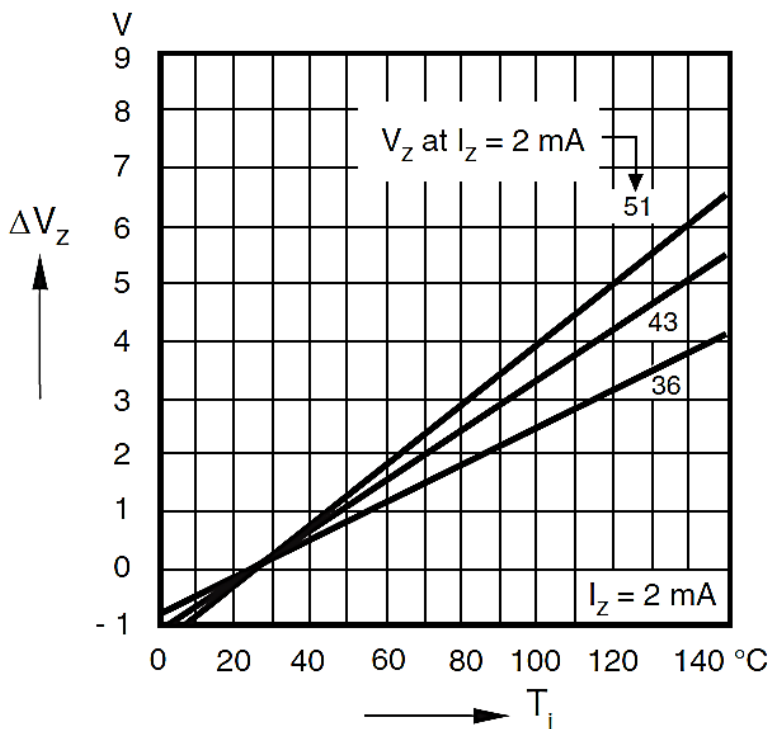

Figure 10. Change of Zener Voltage vs. Junction Temperature Curve



**SMD ZENER DIODES BZT52C SERIES CASE SOD-323**

**RATINGS AND CHARACTERISTIC CURVES** (For Reference Only) - Ta= 25°C Unless Otherwise Specified

Figure 11. Temperature Dependence vs. Zener Voltage. Curve

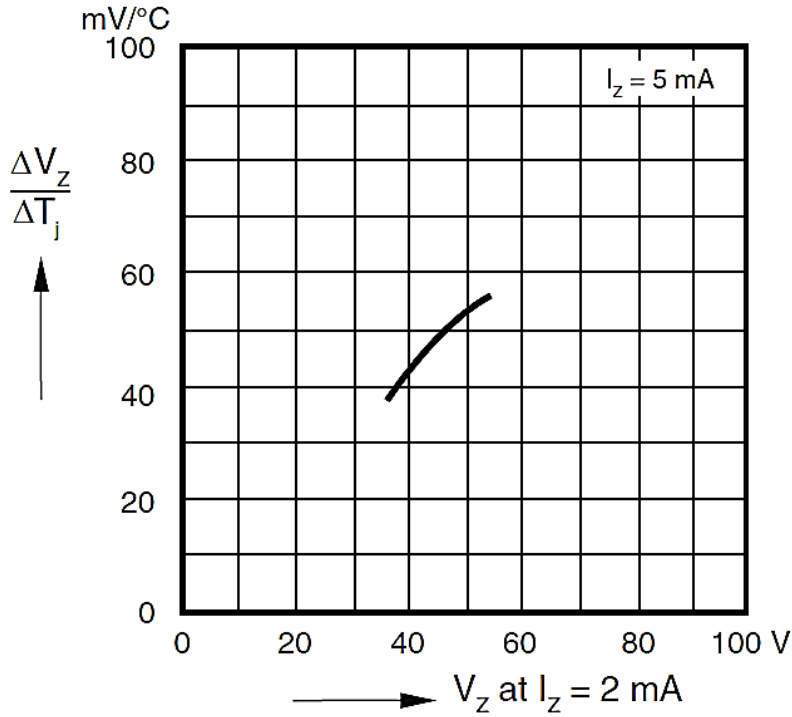
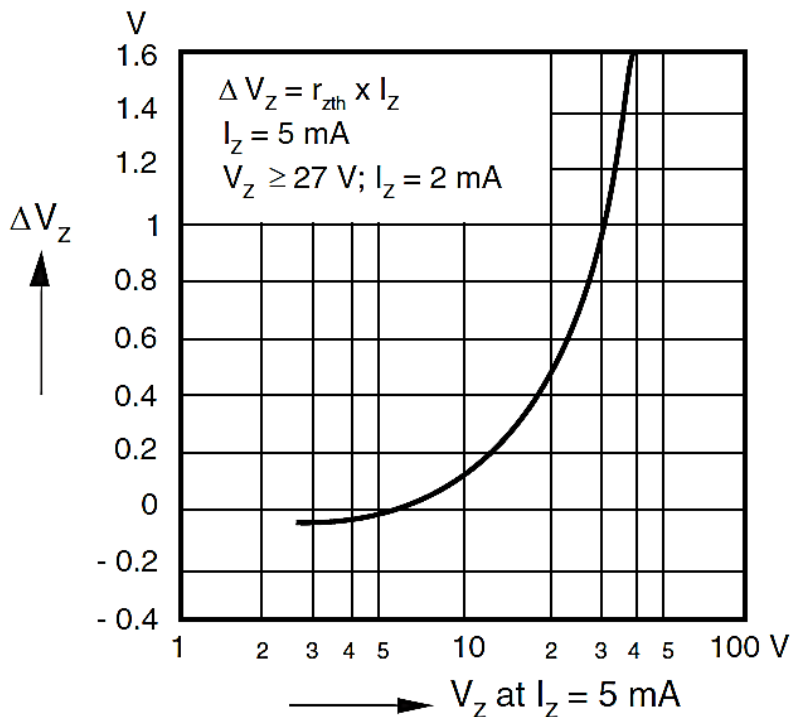

Figure 12. Change of Zener Voltage from Turn-on up to the Point of Thermal Equilibrium vs. Zener Voltage Curve



**SMD ZENER DIODES BZT52C SERIES CASE SOD-323**

**RATINGS AND CHARACTERISTIC CURVES** (For Reference Only) - Ta= 25°C Unless Otherwise Specified

Figure 13. Change of Zener Voltage from Turn-on up to the Point of Thermal Equilibrium vs. Zener Voltage. Curve

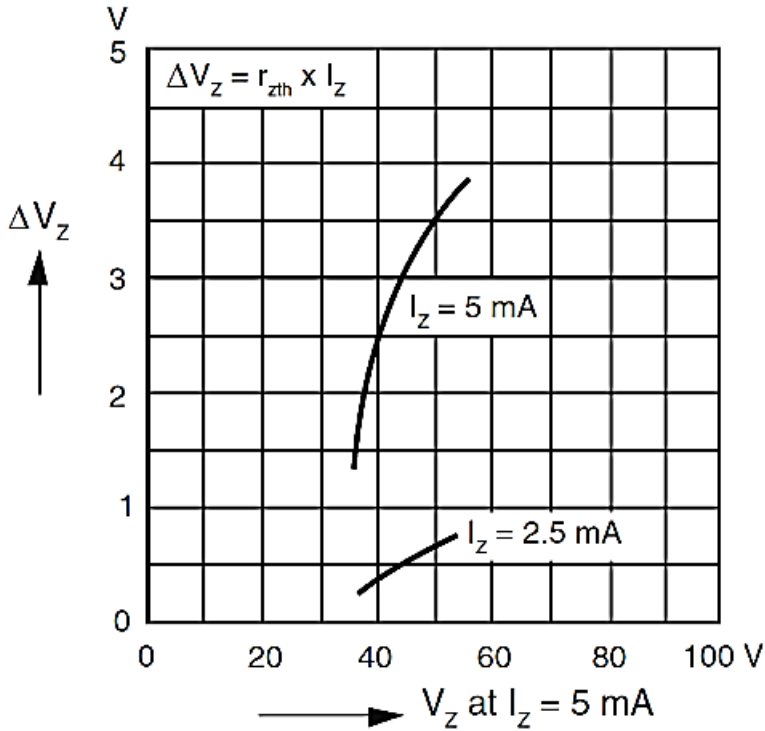
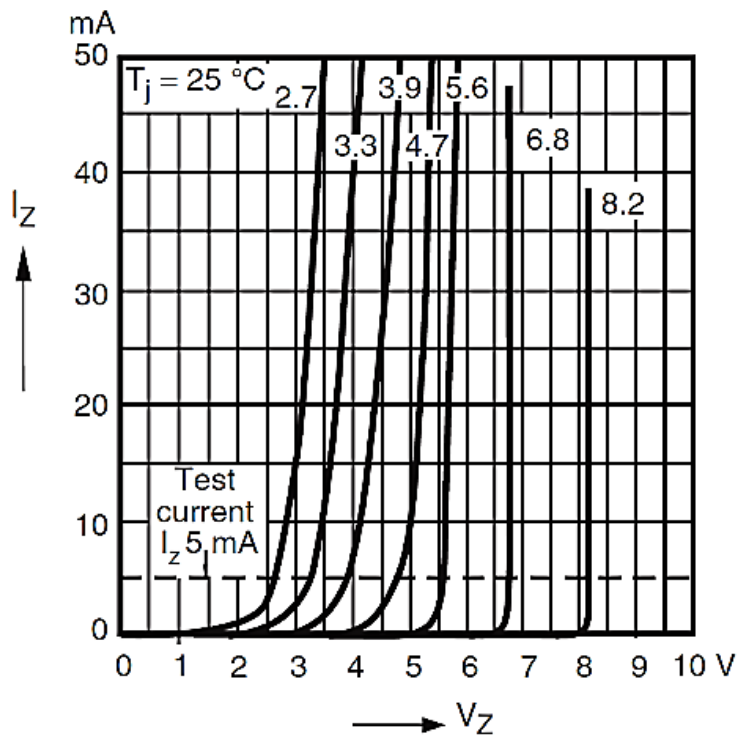

Figure 14. Breakdown Characteristics Curve



**SMD ZENER DIODES BZT52C SERIES CASE SOD-323**

**RATINGS AND CHARACTERISTIC CURVES** (For Reference Only) -  $T_a = 25^\circ\text{C}$  Unless Otherwise Specified

Figure 15. Breakdown Characteristics Curve

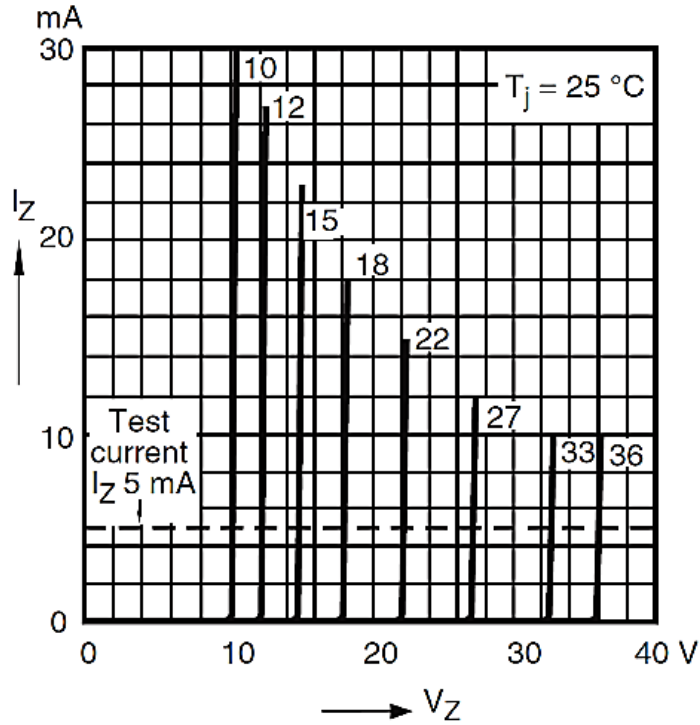
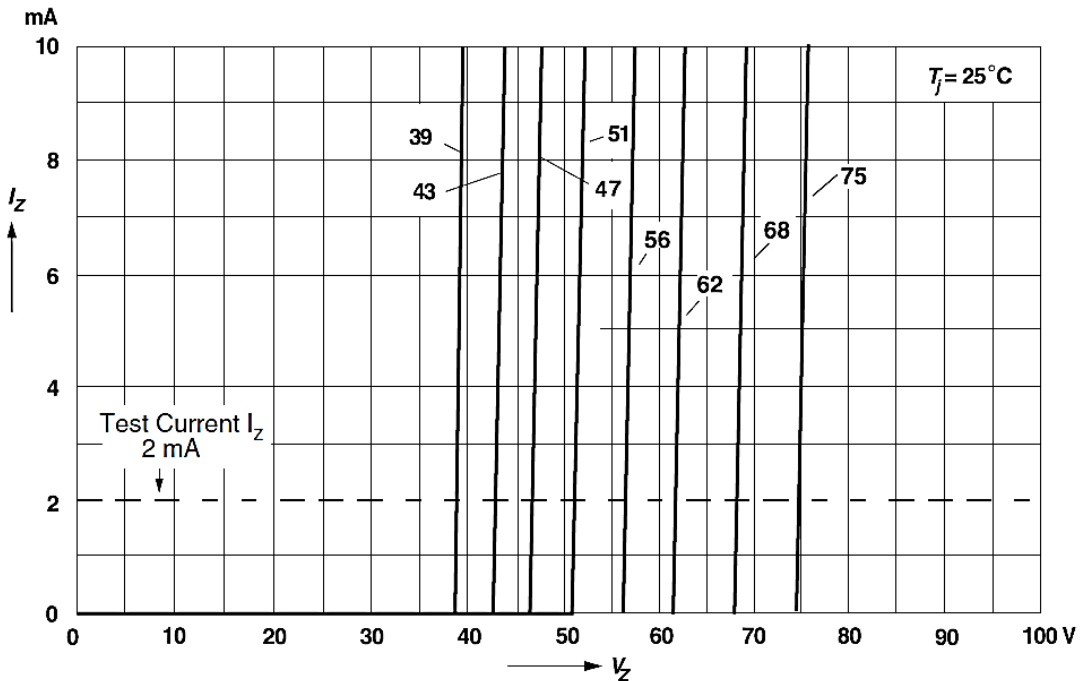

Figure 16. Breakdown Characteristics Curve



**SMD ZENER DIODES BZT52C SERIES CASE SOD-323**
**RELIABILITY**

Number	Experiment Items	Experiment Method And Conditions	Reference Documents
1	Solder Resistance Test	Test 260°C± 5°C for 10 ± 2 sec. Immerse body into solder 1/16" ± 1/32"	MIL-STD-750D METHOD-2031.2
2	Solderability Test	230°C ±5°C for 5 sec.	MIL-STD-750D METHOD-2026.1 0
3	Pull Test	1 kg in axial lead direction for 10 sec.	MIL-STD-750D METHOD-2036.4
4	Bend Test	0.5Kg Weight Applied To Each Lead, Bending Arcs 90 °C ± 5 °C For 3 Times	MIL-STD-750D METHOD-2036.4
5	High Temperature Reverse Bias Test	TA=100°C for 1000 Hours at VR=80% Rated VR	MIL-STD-750D METHOD-1038.4
6	Forward Operation Life Test	TA=25°C Rated Average Rectified Current	MIL-STD-750D METHOD-1027.3
7	Intermittent Operation Life Test	On state: 5 min with rated IRMS Power Off state: 5 min with Cool Forced Air. On and off for 1000 cycles.	MIL-STD-750D METHOD-1036.3
8	Pressure Cooker Test	15 PSIG, TA=121°C, 4 hours	MIL-S-19500 APPENOIXC
9	Temperature Cycling Test	-55°C~+125°C; 30 Minutes For Dwelled Time 5 minutes for transferred time. Total: 10 cycles.	MIL-STD-750D METHOD-1051.7
10	Thermal Shock Test	0°C for 5 minutes., 100°C for 5minutes, Total: 10 cycles	MIL-STD-750D METHOD-1056.7
11	Forward Surge Test	8.3ms Single Sale Sine-wave One Surge.	MIL-STD-750D METHOD-4066.4
12	Humidity Test	TA=65°C, RH=98% for 1000 hours.	MIL-STD-750D METHOD-1021.3
13	High Temperature Storage life Test	150°C for 1000 Hours	MIL-STD-750D METHOD-1031.5

**SMD ZENER DIODES BZT52C SERIES CASE SOD-323**

**SUGGESTED REFLOW PROFILE - For Reference Only**

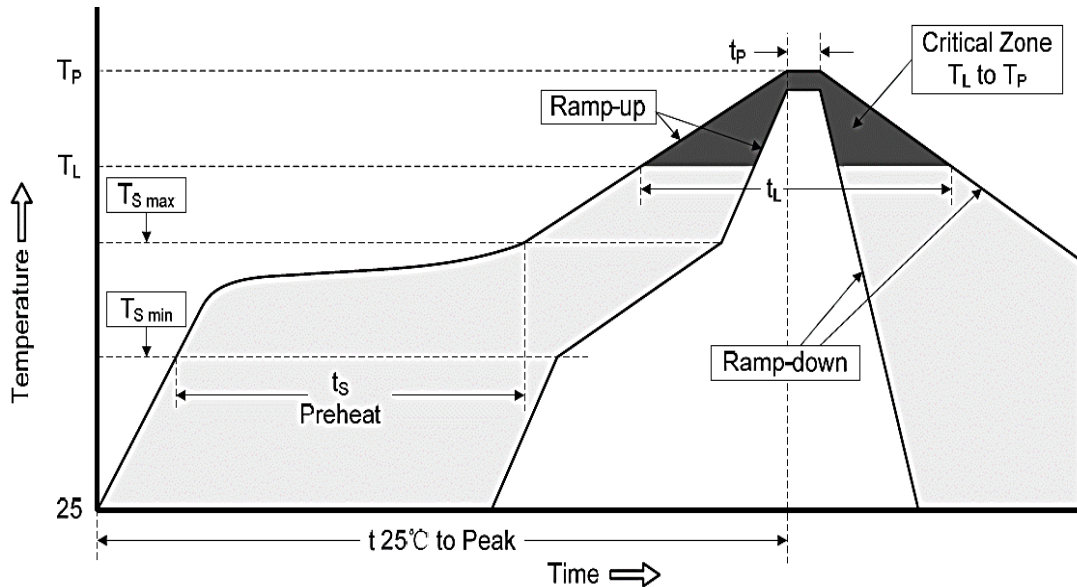

Profile Feature		Pb-Free Assembly
Average Ramp-up Rate ( $T_s$ Max to $T_p$ )		3°C/second Max
Preheat	Temperature Min ( $T_s$ Min.)	150°C
	Temperature Max ( $T_s$ Max.)	200°C
	Time ( $t_s$ Min. to $t_s$ Max.)	60 ~ 180 seconds
Time maintained above	Temperature ( $T_L$ )	217°C
	Time ( $t_L$ )	60 ~ 150 seconds
Peak/Classification Temperature ( $T_p$ )		260 °C
Time within 5°C of actual Peak Temperature ( $t_p$ )		20 ~ 40 seconds
Ramp-down rate		6 °C /Second Max.
Time 25 °C to Peak Temperature		8 minutes Max.
Suggest reflow times		3 Times Max.



**SMD ZENER DIODES BZT52C SERIES CASE SOD-323**
**TAPE/REEL, 3000pcs/Reel (Unit: mm)**

All Devices are packed in accordance with EIA standard RS-481-A and Tape wide 8mm, Component Spacing 4.0mm

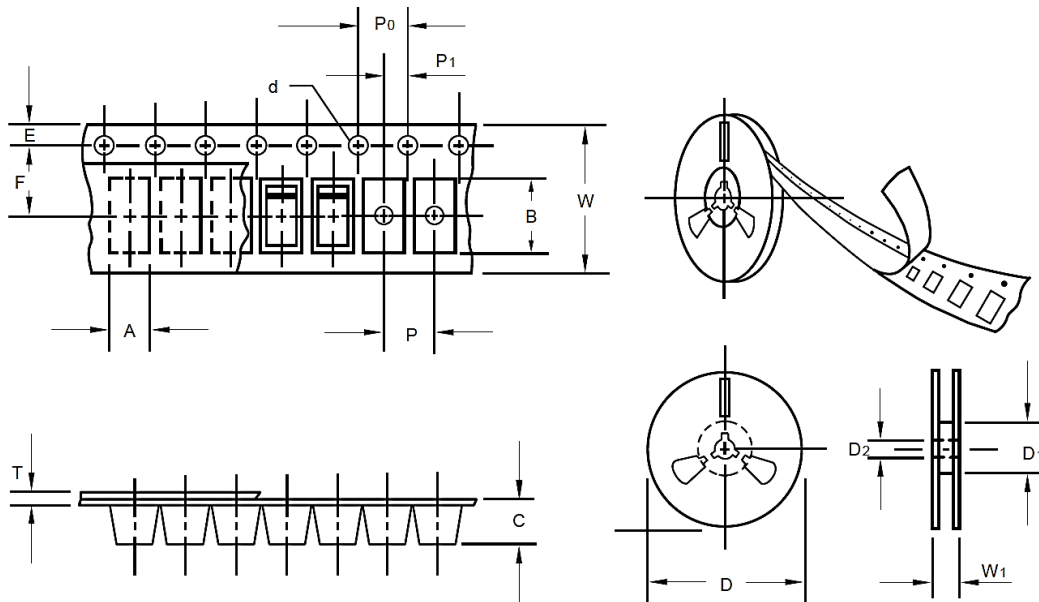

Item	Symbol	Tolerance	Case SOD-323
Carrier width	A	0.1	2.10
Carrier Length	B	0.1	4.00
Carrier Depth	C	0.1	1.60
Sprocket hole	d	0.05	1.55
13"Reel outside diameter	-	-	-
13"Reel inner diameter	-	-	-
7"Reel outside diameter	D	2.0	178.00
7"Reel inner diameter	D1	Min.	50.00
Feed hole diameter	D2	0.5	13.00
Sprocket hole position	E	0.1	1.75
Punch hole position	F	0.1	3.50
Punch hole pitch	P	0.1	4.00
Sprocket hole pitch	P0	0.1	4.00
Embossment center	P1	0.1	2.00
Overall tape thickness	T	0.1	0.25
Tape width	W	0.3	8.15
Reel width	W1	1.0	10.50

## SMD ZENER DIODES BZT52C SERIES CASE SOD-323

### ROHS COMPLIANCE

- The levels of RoHS restricted materials in this product are below the maximum concentration values (also referred to as the threshold limits) permitted for such substances, or are used in an exempted application, in accordance with EU RoHS Directive (EU) 2015/863 EC (RoHS3). RoHS Test Report for this product can be obtained can be obtained at Download Center.

### REACH COMPLIANCE

- REACH substances of high concern (SVHCs) information is available for this product. Since the European Chemical Agency (ECHA) has published notice of their intent to frequently revise the SVHC listing for the foreseeable future, REACH Test Report for this product can be obtained can be obtained at Download Center.

### IMPORTANT NOTES AND DISCLAIMER

- 1) All Product parametric performance is indicated in the Electrical Characteristics for the listed herein test conditions, unless otherwise noted. Product performance may not be indicated by the Electrical Characteristics if operated under different conditions.
- 2) NextGen Component, Inc (*NextGen*) reserves the right to make changes to this document and its products and specifications at any time without notice. Customers should obtain and confirm the latest product information and specifications before final design, purchase or use.
- 3) *NextGen* makes no warranty, representation or guarantee regarding the suitability of its products for any particular purpose, not does NextGen assume any liability for application assistance or customer product design.
- 4) *NextGen* does not warrant or accept any liability with products which are purchased or used for any unintended or unauthorized application. No license is granted by implication or otherwise under any intellectual property rights of NextGen.
- 5) *NextGen* products are not authorized for use as critical components in life support devices or systems without express written approval by *NextGen*.
- 6) *NextGen* requires that customers first obtain an RMA (Returned Merchandise Authorization) number prior to returning any products. Returns must be made within 30 days of the date of invoice, be in the original packaging, unused and like-new condition. At the time of quoting or purchasing, a product may say that it is Non-Cancelable/ Non-Returnable (NCNR). These products are not returnable and not refundable.