



DATA SHEET NO.	R0419 - SMF43A0000S43A	
DATE	Apr.19, 2024	
REVISION	A3	Updated With Most Recent Data
DESCRIPTION AND MAIN PARAMETRICS	<p>SMD Transient Voltage Suppressor (TVs) Diodes, SMF/SOD-123FL series, 2 Pads, Unidirectional Type, Stand-off Voltage 43V, Peak Pulse Power: 200 Watts, Peak Pulse Current: 2.9A Max. Operating Temp. Range -55°C ~+150°C Package in Tape/Reel, 3000pcs/Reel REACH/RoHS/RoHS III Compliant</p>	
CUSTOMER		
CUSTOMER PART NO.		
CROSS REF. PART NO.		
ORIGINAL MFG/PART NO	MDD SMF43A	
PART CODE	SMF43A0000S43A	

VENDOR APPROVE			
Issued/Checked/Approved			
DATE: Apr. 19, 2024			

CUSTOMER APPROVE	
DATE:	

SMD TRANSIENT VOLTAGE SUPPRESSORS DIODES SMF SERIES

MAIN FEATURE

- Low Profile Package
- Glass Passivated Chip Junction
- Low Inductance
- Plastic Package Has Underwriters Laboratory Flammability



APPLICATION

- For SMD application

ELECTRICAL CHARACTERISTICS

- See Page 4~ Page 10

HOW TO ORDER

- Please Follow Up Part Code Guide And Indicate Pat Code When You Order or RFQ

PART CODE GUIDE

RFQ
Request For Quotation

SMF	43A	0000S	43A
1	2	3	4

1. SMF: SMD Transient Voltage Suppressor (TVs) Diodes, SMF/SOD-123FL series
2. 43A: Unidirectional Type, Stand-off Voltage: 43V
3. 0000S: Internal Control Code or Special Parameters Code, Letter A~Z, a~z or digits 0~9
4. 43A: Marking code "43A" on the case surface.

SMD TRANSIENT VOLTAGE SUPPRESSORS DIODES SMF SERIES

DIMENSION (Unit: Inch/mm)

Image for reference



Marking:

See Page 5~ Page 10

Marking Code List

SMF/SOD-123FL



Recommend Pad Layout

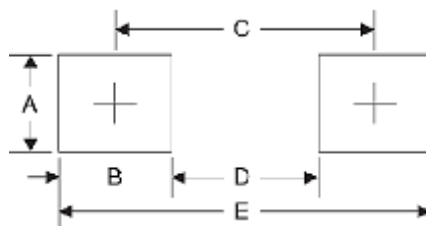

Symbol	Unit (Inch)	Unit (mm)
A	0.047	1.20
B	0.047	1.20
C	0.126	3.20
D	0.079	2.00
E	0.173	4.40

SMD TRANSIENT VOLTAGE SUPPRESSORS DIODES SMF SERIES

MECHANICAL DATA

CASE	TERMINALS	POLARITY	MOUNTING POSITION	MARKING	WEIGHT PER PIECE
JEDEC SMF/SOD-123FL molded plastic body	Solderable per MIL-STD- 750, Method 2026	Polarity symbol marking on body	Any	See Marking Code List	0.00048 ounce, 0.015 grams

MAX. RATING & CHARACTERISTICS - Ratings at 25°C Ambient Temperature Unless Otherwise Specified.

PARAMETER	SYMBOLS	VALUE	UNITS
Peak Pulse Power Dissipation on TA=25°C (Note 1,2,5 Fig 1)	P ppm	200	W
Peak Forward Surge Current 8.3ms Single Half Sine Wave (Note 3) -	I FSM (UNI)	20	A
Steady State Power Dissipation (Note 4)	P M(AV)	1.0	W
Peak Pulse Current on 10/1000 us waveform (Note 1) Fig 2	I PPM	See Table 1~Table 6	A
Operating junction temperature range	T J	-55 ~ +150	°C
Storage temperature range	T stg	-55 ~ +150	°C
Typical Thermal Resistance	R θJA	180	°C/W

Note

1. Non-repetitive current pulse, per Fig 3 and derated above TA=25 °C per Fig 2
2. Mounted on 5.0*5.0mm copper pads to each terminal
3. 8.3ms single half sinewave or equivalent square wave, duty cycle=4 pulsed per minute Max.
4. Lead temperature at T L =75 °C
5. Peak pulse power waveform is tp =10/1000µs
6. A transient suppressor is selected according to the working peak reverse voltage (V RWM), which should be equal to or great than the DC or continuous peak operating voltage level.

SMD TRANSIENT VOLTAGE SUPPRESSORS DIODES SMF SERIES
UNIDIRECTIONAL TYPE- ELECTRICAL CHARACTERISTICS - Ta = 25°C

Table 1

Part Code	Reverse Stand-off Voltage	Breakdown Voltage		Test Current	Reverse Leakage Max.	Max. Clamp Voltage	Peak Pulse Current	Marking Code
		V _{BR} @ I _T						
	V _{RMV}	Min	Max	I _T	I _R @ V _{RWM}	V _C @ I _{PPM}	I _{PPM}	
	V	V	V	mA	µA	V	A	
SMF050A00S050A	5	6.4	7	10	400	9.2	21.7	5.0A
SMF060A00S060A	6	6.67	7.37	10	400	10.3	19.4	6.0A
SMF065A00S065A	6.5	7.22	7.98	10	250	11.2	17.9	6.5A
SMF070A00S070A	7	7.78	8.6	10	100	12	16.7	7.0A
SMF075A00S075A	7.5	8.33	9.2	1	50	12.9	15.5	7.5A
SMF080A00S080A	8	8.89	9.83	1	25	13.6	14.7	8.0A
SMF085A00S085A	8.5	9.44	10.4	1	10	14.4	13.9	8.5A
SMF090A00S090A	9	10	11.1	1	5	15.4	13	9.0A
SMF10A0000S10A	10	11.1	12.3	1	2.5	17	11.8	10A
SMF11A0000S11A	11	12.2	13.5	1	2.5	18.2	11	11A
SMF12A0000S12A	12	13.3	14.7	1	2.5	19.9	10.1	12A
SMF13A0000S13A	13	14.4	15.9	1	1	21.5	9.3	13A
SMF14A0000S14A	14	15.6	17.2	1	1	23.2	8.6	14A
SMF15A0000S15A	15	16.7	18.5	1	1	24.4	8.2	15A
SMF16A0000S16A	16	17.8	19.7	1	1	26	7.7	16A
SMF17A0000S17A	17	18.9	20.9	1	1	27.6	7.2	17A
SMF18A0000S18A	18	20	22.1	1	1	29.2	6.8	18A
SMF20A0000S20A	20	22.2	24.5	1	1	32.4	6.2	20A
SMF22A0000S22A	22	24.4	26.9	1	1	35.5	5.6	22A
SMF24A0000S24A	24	26.7	29.5	1	1	38.9	5.1	24A

SMD TRANSIENT VOLTAGE SUPPRESSORS DIODES SMF SERIES
UNIDIRECTIONAL TYPE- ELECTRICAL CHARACTERISTICS - Ta = 25°C

Table 2

Part Code	Reverse Stand-off Voltage	Breakdown Voltage		Test Current	Reverse Leakage Max.	Max. Clamp Voltage	Peak Pulse Current	Marking Code
		V _{BR} @ I _T						
	V _{RMV}	Min	Max	I _T	I _R @ V _{RWM}	V _C @ I _{PPM}	I _{PPM}	
V	V	V	mA	µA	V	A		
SMF26A0000S26A	26	28.9	31.9	1	1	42.1	4.8	26A
SMF28A0000S28A	28	31.1	34.4	1	1	45.4	4.4	28A
SMF30A0000S30A	30	33.3	36.8	1	1	48.4	4.1	30A
SMF33A0000S33A	33	36.7	40.6	1	1	53.3	3.8	33A
SMF36A0000S36A	36	40	44.2	1	1	58.1	3.4	36A
SMF40A0000S40A	40	44.4	49.1	1	1	64.5	3.1	40A
SMF43A0000S43A	43	47.8	52.8	1	1	69.4	2.9	43A
SMF45A0000S45A	45	50	55.3	1	1	72.7	2.8	45A
SMF48A0000S48A	48	53.3	58.9	1	1	77.4	2.6	48A
SMF51A0000S51A	51	56.7	62.7	1	1	82.4	2.4	51A
SMF54A0000S54A	54	60	66.3	1	1	87.1	2.3	54A
SMF58A0000S58A	58	64.4	71.2	1	1	93.6	2.1	58A
SMF60A0000S60A	60	66.7	73.7	1	1	96.8	1.8	60A
SMF64A0000S64A	64	71.1	78.6	1	1	103	1.7	64A
SMF70A0000S70A	70	77.8	86	1	1	113	1.5	70A
SMF75A0000S75A	75	83.3	92.1	1	1	121	1.4	75A
SMF78A0000S78A	78	86.7	95.8	1	1	126	1.4	78A
SMF85A0000S85A	85	94.4	104	1	1	137	1.3	85A
SMF90A0000S90A	90	100	111	1	1	146	1.2	90A
SMF100A0000S100A	100	111	123	1	1	162	1.1	100A

SMD TRANSIENT VOLTAGE SUPPRESSORS DIODES SMF SERIES
UNIDIRECTIONAL TYPE- ELECTRICAL CHARACTERISTICS - Ta = 25°C

Table 3

Part Code	Reverse Stand-off Voltage	Breakdown Voltage		Test Current	Reverse Leakage Max.	Max. Clamp Voltage	Peak Pulse Current	Marking Code
		V _{BR} @ I _T						
	V _{RMV}	Min	Max	I _T	I _R @ V _{RWM}	V _C @ I _{PPM}	I _{PPM}	
V	V	V	mA	µA	V	A		
SMF110A00S110A	110	122	135	1	1	177	1	110A
SMF120A00S120A	120	133	147	1	1	193	0.9	120A
SMF130A00S130A	130	144	159	1	1	209	0.8	130A
SMF150A00S150A	150	167	185	1	1	243	0.7	150A
SMF160A00S160A	160	178	197	1	1	259	0.7	160A
SMF170A00S170A	170	189	209	1	1	275	0.6	170A
SMF180A00S180A	180	201	222	1	1	292	0.5	180A
SMF190A00S190A	190	211	232	1	1	308	0.5	190A
SMF200A00S200A	200	224	247	1	1	324	0.5	200A
SMF220A00S220A	220	246	272	1	1	356	0.5	220A
SMF250A00S250A	250	279	309	1	1	405	0.5	250A
SMF300A00S300A	300	335	371	1	1	486	0.45	300A
SMF350A00S350A	350	391	432	1	1	567	0.4	350A
SMF400A00S400A	400	447	494	1	1	648	0.35	400A
SMF440A00S440A	440	492	543	1	1	713	0.3	440A

SMD TRANSIENT VOLTAGE SUPPRESSORS DIODES SMF SERIES
BIDIRECTIONAL TYPE- ELECTRICAL CHARACTERISTICS - Ta = 25°C

Table 4

Part Code	Reverse Stand-off Voltage	Breakdown Voltage		Test Current	Reverse Leakage Max.	Max. Clamp Voltage	Peak Pulse Current	Marking Code
		V _{BR} @ I _T						
	V _{RMV}	Min	Max	I _T	I _R @ V _{RWM}	V _C @ I _{PPM}	I _{PPM}	
	V	V	V	mA	µA	V	A	
SMF050CAS050CA	5	6.4	7	10	400	9.2	21.7	5.0CA
SMF060CAS060CA	6	6.67	7.37	10	400	10.3	19.4	6.0CA
SMF065CAS065CA	6.5	7.22	7.98	10	250	11.2	17.9	6.5CA
SMF070CAS070CA	7	7.78	8.6	10	100	12	16.7	7.0CA
SMF075CAS075CA	7.5	8.33	9.2	1	50	12.9	15.5	7.5CA
SMF080CAS080CA	8	8.89	9.83	1	25	13.6	14.7	8.0CA
SMF085CAS085CA	8.5	9.44	10.4	1	10	14.4	13.9	8.5CA
SMF090CAS090CA	9	10	11.1	1	5	15.4	13	9.0CA
SMF10CA00S10CA	10	11.1	12.3	1	2.5	17	11.8	10CA
SMF11CA00S11CA	11	12.2	13.5	1	2.5	18.2	11	11CA
SMF12CA00S12CA	12	13.3	14.7	1	2.5	19.9	10.1	12CA
SMF13CA00S13CA	13	14.4	15.9	1	1	21.5	9.3	13CA
SMF14CA00S14CA	14	15.6	17.2	1	1	23.2	8.6	14CA
SMF15CA00S15CA	15	16.7	18.5	1	1	24.4	8.2	15CA
SMF16CA00S16CA	16	17.8	19.7	1	1	26	7.7	16CA
SMF17CA00S17CA	17	18.9	20.9	1	1	27.6	7.2	17CA
SMF18CA00S18CA	18	20	22.1	1	1	29.2	6.8	18CA
SMF20CA00S20CA	20	22.2	24.5	1	1	32.4	6.2	20CA
SMF22CA00S22CA	22	24.4	26.9	1	1	35.5	5.6	22CA
SMF24CA00S24CA	24	26.7	29.5	1	1	38.9	5.1	24CA

SMD TRANSIENT VOLTAGE SUPPRESSORS DIODES SMF SERIES
BIDIRECTIONAL TYPE- ELECTRICAL CHARACTERISTICS - Ta = 25°C

Table 5

Part Code	Reverse Stand-off Voltage	Breakdown Voltage		Test Current	Reverse Leakage Max.	Max. Clamp Voltage	Peak Pulse Current	Marking Code
		V _{BR} @ I _T						
	V _{RMV}	Min	Max	I _T	I _R @ V _{RWM}	V _C @ I _{PPM}	I _{PPM}	
	V	V	V	mA	µA	V	A	
SMF26CA00S26CA	26	28.9	31.9	1	1	42.1	4.8	26CA
SMF28CA00S28CA	28	31.1	34.4	1	1	45.4	4.4	28CA
SMF30CA00S30CA	30	33.3	36.8	1	1	48.4	4.1	30CA
SMF33CA00S33CA	33	36.7	40.6	1	1	53.3	3.8	33CA
SMF36CA00S36CA	36	40	44.2	1	1	58.1	3.4	36CA
SMF40CA00S40CA	40	44.4	49.1	1	1	64.5	3.1	40CA
SMF43CA00S43CA	43	47.8	52.8	1	1	69.4	2.9	43CA
SMF45CA00S45CA	45	50	55.3	1	1	72.7	2.8	45CA
SMF48CA00S48CA	48	53.3	58.9	1	1	77.4	2.6	48CA
SMF51CA00S51CA	51	56.7	62.7	1	1	82.4	2.4	51CA
SMF54CA00S54CA	54	60	66.3	1	1	87.1	2.3	54CA
SMF58CA00S58CA	58	64.4	71.2	1	1	93.6	2.1	58CA
SMF60CA00S60CA	60	66.7	73.7	1	1	96.8	1.8	60CA
SMF64CA00S64CA	64	71.1	78.6	1	1	103	1.7	64CA
SMF70CA00S70CA	70	77.8	86	1	1	113	1.5	70CA
SMF75CA00S75CA	75	83.3	92.1	1	1	121	1.4	75CA
SMF78CA00S78CA	78	86.7	95.8	1	1	126	1.4	78CA
SMF85CA00S85CA	85	94.4	104	1	1	137	1.3	85CA
SMF90CA00S90CA	90	100	111	1	1	146	1.2	90CA
SMF100CAS100CA	100	111	123	1	1	162	1.1	100CA

SMD TRANSIENT VOLTAGE SUPPRESSORS DIODES SMF SERIES
BIDIRECTIONAL TYPE- ELECTRICAL CHARACTERISTICS - Ta = 25°C

Table 6

Part Code	Reverse Stand-off Voltage	Breakdown Voltage		Test Current	Reverse Leakage Max.	Max. Clamp Voltage	Peak Pulse Current	Marking Code
		V _{BR} @ I _T						
	V _{RMV}	Min	Max	I _T	I _R @ V _{RWM}	V _C @ I _{PPM}	I _{PPM}	
V	V	V	mA	μA	V	A		
SMF110CAS110CA	110	122	135	1	1	177	1	110CA
SMF120CAS120CA	120	133	147	1	1	193	0.9	120CA
SMF130CAS130CA	130	144	159	1	1	209	0.8	130CA
SMF150CAS150CA	150	167	185	1	1	243	0.7	150CA
SMF160CAS160CA	160	178	197	1	1	259	0.7	160CA
SMF170CAS170CA	170	189	209	1	1	275	0.6	170CA
SMF180CAS180CA	180	201	222	1	1	292	0.5	180CA
SMF190CAS190CA	190	211	232	1	1	308	0.5	190CA
SMF200CAS200CA	200	224	247	1	1	324	0.5	200CA
SMF220CAS220CA	220	246	272	1	1	356	0.5	220CA
SMF250CAS250CA	250	279	309	1	1	405	0.5	250CA
SMF300CAS300CA	300	335	371	1	1	486	0.45	300CA
SMF350CAS350CA	350	391	432	1	1	567	0.4	350CA
SMF400CAS400CA	400	447	494	1	1	648	0.35	400CA
SMF440CAS440CA	440	492	543	1	1	713	0.3	440CA

SMD TRANSIENT VOLTAGE SUPPRESSORS DIODES SMF SERIES
RELIABILITY

NUMBER	EXPERIMENT ITEMS	EXPERIMENT METHOD AND CONDITIONS	REFERENCE DOCUMENTS
1	Solder Resistance Test	Test 260°C± 5°C for 10 ± 2 sec. Immerse body into solder 1/16" ± 1/32"	MIL-STD-750D METHOD-2031.2
2	Solderability Test	230°C ±5°C for 5 sec.	MIL-STD-750D METHOD-2026.1 0
3	Pull Test	1 kg in axial lead direction for 10 sec.	MIL-STD-750D METHOD-2036.4
4	Bend Test	0.5Kg Weight Applied To Each Lead, Bending Arcs 90 °C ± 5 °C For 3 Times	MIL-STD-750D METHOD-2036.4
5	High Temperature Reverse Bias Test	TA=100°C for 1000 Hours at VR=80% Rated VR	MIL-STD-750D METHOD-1038.4
6	Forward Operation Life Test	TA=25°C Rated Average Rectified Current	MIL-STD-750D METHOD-1027.3
7	Intermittent Operation Life Test	On state: 5 min with rated IRMS Power Off state: 5 min with Cool Forced Air. On and off for 1000 cycles.	MIL-STD-750D METHOD-1036.3
8	Pressure Cooker Test	15 PSIG, TA=121°C, 4 hours	MIL-S-19500 APPENOIXC
9	Temperature Cycling Test	-55°C~+125°C; 30 Minutes For Dwelled Time 5 minutes for transferred time. Total: 10 cycles.	MIL-STD-750D METHOD-1051.7
10	Thermal Shock Test	0°C for 5 minutes., 100°C for 5minutes, Total: 10 cycles	MIL-STD-750D METHOD-1056.7
11	Forward Surge Test	8.3ms Single Sale Sine-wave One Surge.	MIL-STD-750D METHOD-4066.4
12	Humidity Test	TA=65°C, RH=98% for 1000 hours.	MIL-STD-750D METHOD-1021.3
13	High Temperature Storage life Test	150°C for 1000 Hours	MIL-STD-750D METHOD-1031.5

SMD TRANSIENT VOLTAGE SUPPRESSORS DIODES SMF SERIES

SUGGESTED REFLOW PROFILE (For Reference Only)



PROFILE FEATURE		PB-FREE ASSEMBLY
Average Ramp-up Rate (Ts Max to Tp)		3°C/second Max
Preheat	Temperature Min (Ts Min.)	150°C
	Temperature Max (Ts Max.)	200°C
	Time (ts Min. to ts Max.)	60 ~ 180 seconds
Time maintained above	Temperature (Tl)	217°C
	Time (tl)	60 ~ 150 seconds
Peak/Classification Temperature (Tp)		260 °C
Time within 5°C of actual Peak Temperature (tp)		20 ~ 40 seconds
Ramp-down rate		6 °C /Second Max.
Time 25 °C to Peak Temperature		8 minutes Max.
Suggest reflow times		3 Times Max.

SMD TRANSIENT VOLTAGE SUPPRESSORS DIODES SMF SERIES

RATINGS AND CHARACTERISTIC CURVES (For Reference Only)

Fig.1 Peak Pulse Power Rating Curve

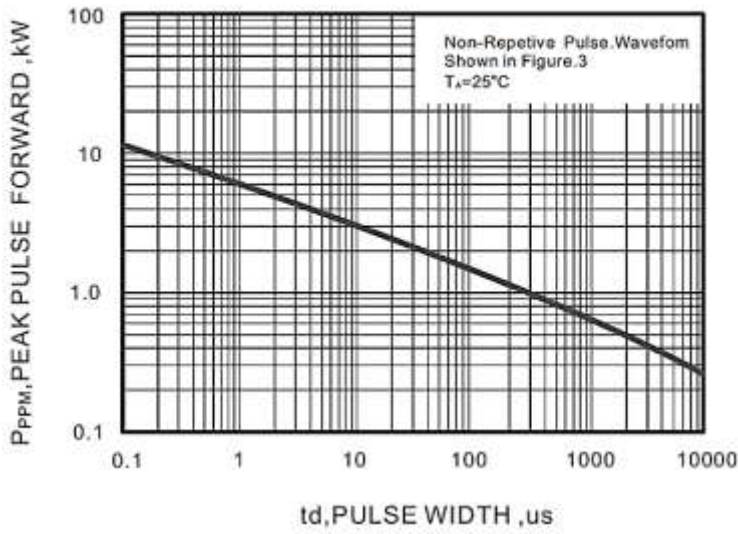
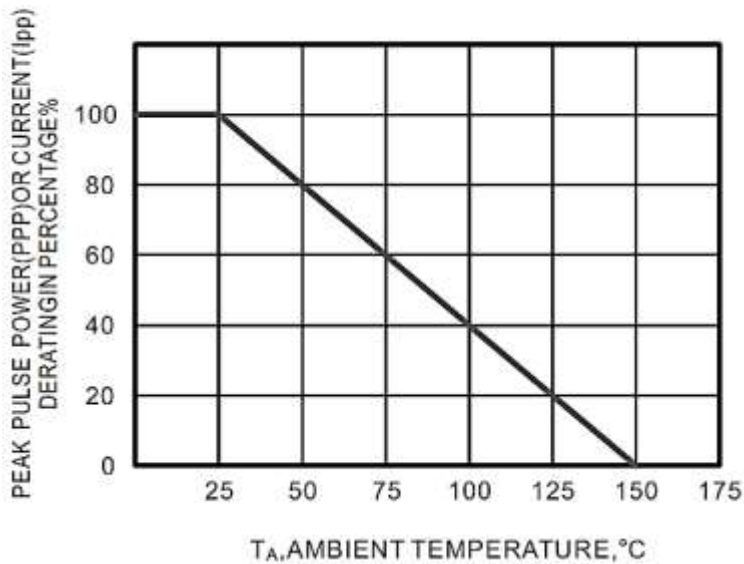

Fig.2 Forward Current Derating Curve



SMD TRANSIENT VOLTAGE SUPPRESSORS DIODES SMF SERIES

RATINGS AND CHARACTERISTIC CURVES (For Reference Only)

Fig.3 Pulse Waveform

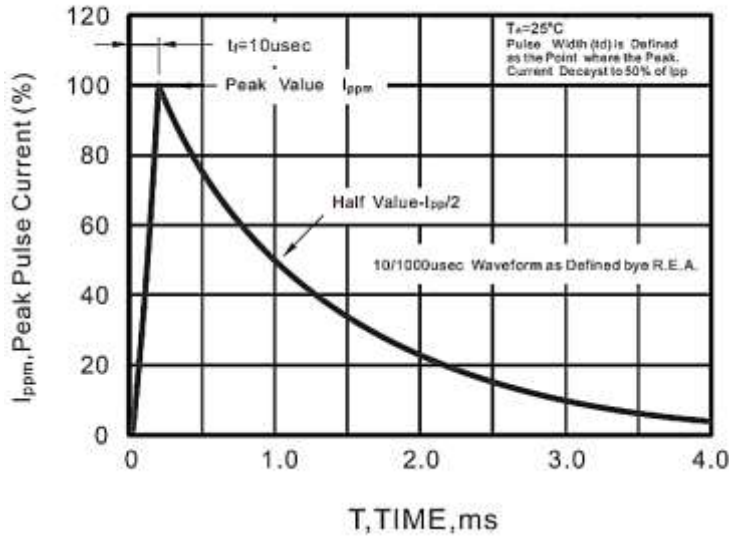
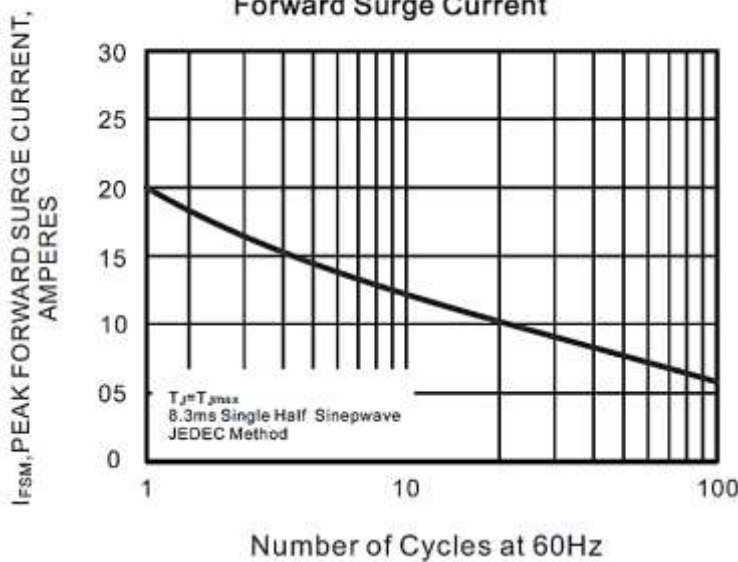

Fig.4 Maximum Non-Repetitive Peak Forward Surge Current



SMD TRANSIENT VOLTAGE SUPPRESSORS DIODES SMF SERIES

TAPE/REEL (Unit: mm)

All Devices are packed in accordance with EIA standard RS-481-A and specifications.

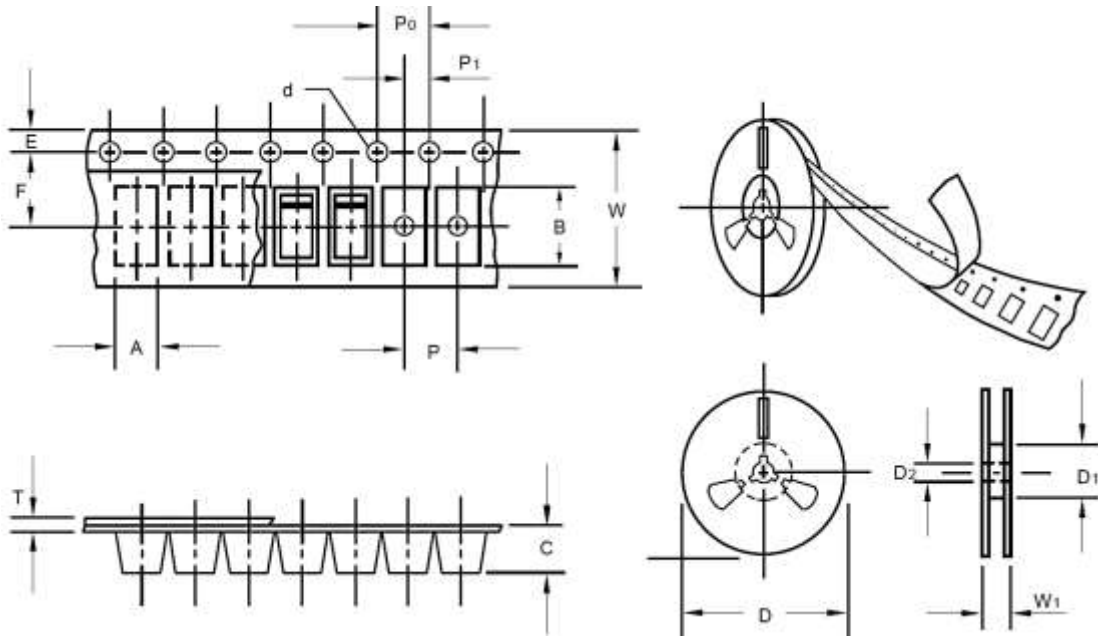

ITEM	SYMBOL	TOLERANCE	SMF/SOD-123FL
Carrier width	A	0.1	2.10
Carrier Length	B	0.1	4.00
Carrier Depth	C	0.1	1.60
Sprocket hole	d	0.05	1.55
7"Reel outside diameter	D	2.0	178.00
7"Reel inner diameter	D1	Min.	50.00
Feed hole diameter	D2	0.5	13.00
Sprocket hole position	E	0.1	1.75
Punch hole position	F	0.1	3.50
Punch hole pitch	P	0.1	4.00
Sprocket hole pitch	P0	0.1	4.00
Embossment center	P1	0.1	2.00
Overall tape thickness	T	0.1	0.25
Tape width	W	0.3	8.15
Reel width	W1	1.0	10.50
Package	3000pcs/Reel, 2 Reels/ Box		
G.W/Box	1 LB		

SMD TRANSIENT VOLTAGE SUPPRESSORS DIODES SMF SERIES

IMPORTANT NOTES AND DISCLAIMER

1. RoHS Compliance: The levels of RoHS restricted materials in this product are below the maximum concentration values (also referred to as the threshold limits) permitted for such substances, or are used in an exempted application, in accordance with EU RoHS Directive (EU) 2015/863 EC (RoHS3). RoHS Test Report for this product can be obtained at Download Center.
2. REACH Compliance: REACH substances of high concern (SVHCs) information is available for this product. Since the European Chemical Agency (ECHA) has published notice of their intent to frequently revise the SVHC listing for the foreseeable future, REACH Test Report for this product can be obtained at Download Center.
3. All Product parametric performance is indicated in the Electrical Characteristics for the listed herein test conditions, unless otherwise noted. Product performance may not be indicated by the Electrical Characteristics if operated under different conditions.
4. NextGen Component, Inc (*NextGen*) reserves the right to make changes to this document and its products and specifications at any time without notice. Customers should obtain and confirm the latest product information and specifications before final design, purchase or use.
5. *NextGen* makes no warranty, representation or guarantee regarding the suitability of its products for any particular purpose, not does NextGen assume any liability for application assistance or customer product design.
6. *NextGen* does not warrant or accept any liability with products which are purchased or used for any unintended or unauthorized application. No license is granted by implication or otherwise under any intellectual property rights of *NextGen*.
7. *NextGen* products are not authorized for use as critical components in life support devices or systems without express written approval by *NextGen*.
8. *NextGen* requires that customers first obtain an RMA (Returned Merchandise Authorization) number prior to returning any products. Returns must be made within 30 days of the date of invoice, be in the original packaging, unused and like-new condition. At the time of quoting or purchasing, a product may say that it is Non-Cancelable/ Non-Returnable (NCNR). These products are not returnable and not refundable.